

# SL POWER LU225 SERIES

225 Watts Single Output  
LED & Industry Grade



LED



Industrial

Advanced Energy’s SL Power LU225 medically-approved AC-DC power supplies are available with a nominal main output of 12 V, 24 V, 36 V, 48 V or 56 V. LU225 power supplies provide up to 225 Watts of output power with fan cooling. All models have output overvoltage, short circuit and overload protection and a 2.2 x 4.16 x 1.5 inch form factor.

## AT A GLANCE

### Total Power

225 Watts

### Input Voltage

90 to 305 VAC

### # of Outputs

Single



## SPECIAL FEATURES

- 225 Watts Fan Cooled, 200LFM
- 180 Watts Conduction Cooled
- 150 Watts Convection Cooled
- Universal Input 90 to 264 VAC
- 0.5W Power Consumption at No-load
- Active Inrush Current Limiter – 15A
- EN55015 (EN55032) Class B Conducted EMI
- -10°C to +70°C Operating Temperature
- ROHS Compliant

## SAFETY

- EN EN62368-1
- CSA CSA62368-1
- UL UL62368-1
- CB IEC62368-1

**ELECTRICAL SPECIFICATIONS**

<b>Input</b>	
Input Range	100 to 277 VAC, ±10%, 47-63Hz
Input Current	2.8A max at 115VAC, 1.3A max at 277VAC
Inrush Current	15A peak, cold start @ 277VAC input, turn on at AC zero crossing
Input fuses	provided on all models
Earth Leakage Current	<500uA@277VAC, 60Hz, NC
Efficiency	12V & 24V: 88% typical at 115VAC; 90% typical at 277VAC 36V & 48V & 56V: 90% typical at 115VAC; 92% typical at 277VAC
No Load Input Power	<0.5W
Switching Frequency	PFC: Variable 40 -150kHz Main Converter: Variable 35-200kHz, 65-70kHz at full load
Isolation Voltage	Input/Ground: 1800VAC Input/Output: 3000VAC Output/Ground: 500VAC
<b>Output</b>	
Output Voltage	See "Ordering information" section
Output Voltage Adjustment	±5%
Ripple and Noise	0.5% of Vout, rms; 1% of Vout, pk-pk
Total Regulation	±3% combined line, load and initial setting
Minimum Load	Not required
Turn On Delay	<1 Seconds at 115Vac, full load
Hold Up Time	12mS minimum from loss of ac input at 115Vac, full load
Transient Response	<20ms response time for return to within 1% of final value for 5% to 50% or 50% to 5% load, $\Delta i/\Delta t < 0.2A/us$ . Max. voltage deviation is ±3% of final value. <1ms response time for return to within 1% of final value for 50% to 100% or 100% to 50% load, $\Delta i/\Delta t < 0.2A/us$ . Max. voltage deviation is ±3% of final value. <25ms response time for return to within 1% of final value for 5% to 100% or 100% to 5% load, $\Delta i/\Delta t < 0.2A/us$ . Max. voltage deviation is ±4% of final value.
<b>Reliability</b>	
MTBF	438,540 hours @ 110VAC, 25°C ambient, Telcordia SR-332 issue 3, Level: 0/1.Environment: Ground, fixed, controlled
Warranty	3 years
<b>Protection</b>	
Overvoltage Protection	OVP latch, remove AC input to reset
Short circuit Protection	Hiccup Mode, auto recovery. A direct hard short may latch off the converter; remove AC input to reset
Overtemperature Protection	Sensing transformer temperature, 165°C, Auto recover
Overload Protection	Hiccup Mode

## EMI/EMC COMPLIANCE

Conducted emissions	EN55015 (EN55032) Class B, FCC Part 15, Subpart B, Class B
Radiated emissions	EN55022 (EN55032) Class A, FCC Part 15, Subpart B, Class A with 8dB Margin. Addition of cores on external wiring will help the system pass class B (Application notes are available)
Harmonic current emissions	EN61000-3-2, Class A, D For Class C from 1W input power to full load by 10% increment
Voltage fluctuations & flicker	EN61000-3-3, Complies (dmax<6%)
Electro static discharge immunity	EN61000-4-2, 6kV Contact Discharge, 8kV air discharge
Radiated RF EM fields susceptibility	EN61000-4-3, 3V/m
Rated Power Frequency magnetic fields	EN61000-4-8, 3A/m
Electrical fast transients / bursts	EN61000-4-4, 2kV/5kHz
Surges line to line (DM) and line to ground (CM)	EN61000-4-5, 1kV differential, 2kV common-mode
Conducted RF Immunity	EN61000-4-6, 3Vrms
Voltage dips	EN61000-4-11, 100%, 10ms; 30%, 500ms; 60%, 100ms; Performance Criteria A, A, & A at 58% load

## ENVIRONMENTAL SPECIFICATIONS

Vibration	Operating: 0.003 g <sup>2</sup> /Hz, 1.5 grams overall, 3 axes, 1 hr/axis Non-operating: 0.026 g <sup>2</sup> /Hz, 5.0 grms overall, 3 axes, 10 mins/axis
Shock	Operating: Half-sine shock waveform. Impact Acceleration: 20g, Pulse duration: 10ms. Cycles: 3 times per axis in X,Y, Z direction, 6 shocks total Non-Operating: Half-sine shock waveform. Impact Acceleration: 40g, Pulse duration: 10ms. Cycles: 3 times per direction on 3 axes (X,Y,Z), 6 shocks total
Cooling	Fan, Conduction, Convection
Heat - Sink Temperature	To maintain Safety approval & life expectancy, heatsink temperature should not exceed 85°C
Storage temperature	-40°C to +85°C
Altitude	Operating: -457 to 3,000 m. Non-operating: -457 to 12,192 m
Relative humidity	5% to 95%, non-condensing
Weight	370g

ORDERING INFORMATION

Model Number <sup>1</sup>	Output Voltage	Output Current (w/200LFM air)	Output Current (Conduction)	Output Current (Convection)	Ripple & Noise	Total Regulation	OVP Threshold
LU225S12K	12 V	17.5 A	13.3 A	11.67A	1%	±2%	14.1±1.0 Vdc
LU225S24K	24 V	9.38 A	7.50 A	6.25A	1%	±2%	27.6±1.0 Vdc
LU225S36K	36 V	6.25 A	5.00 A	4.16A	1%	±2%	39.8±1.0 Vdc
LU225S48K	48 V	4.69 A	3.75 A	3.125A	1%	±2%	55.2±2.0 Vdc
LU225S56K	56 V	4.00 A	3.2 A	2.68A	1%	±2%	64.3±2.0 Vdc

Notes:

1. Replace K in the model number with KL for top mount Version. Example: LU225S56KL.

SAFETY

EN	EN62368-1
CSA	CAN/CSA62368-1
UL	UL62368-1
IEC	IEC62368-1

POWER DERATING

Ambient Temperature	Cooling Method	Max Wattage
50°C	Forced Air, 200 LFM	225
60°C	Forced Air, 200 LFM	190
70°C	Forced Air, 200 LFM	160
50°C with Max. Temperature of heat-sink to be held under TBD°C	Conduction	180
60°C with Max. Temperature of heat-sink to be held under TBD°C	Conduction	165
50°C	Conduction	140

MECHANICAL DRAWING

Standard

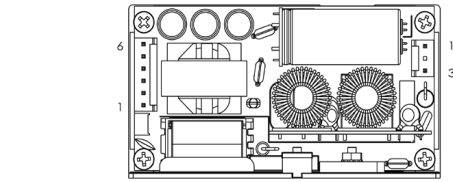

CONNECTOR INFORMATION			
INPUT (J1)		MATING CONNECTOR Tyco/AMP 640250-3 Terminals: 3-640252-1	CONFIGURATION #1 AC NEUTRA #2 EMPTY #3 AC LINE
OUTPUT (J3)		MATING CONNECTOR AMP 640250-6 Terminals: 3-640252-1	CONFIGURATION Pin 1 -Vout Pin 2 -Vout Pin 3 -Vout Pin 4 +Vout Pin 5 +Vout Pin 6 +Vout

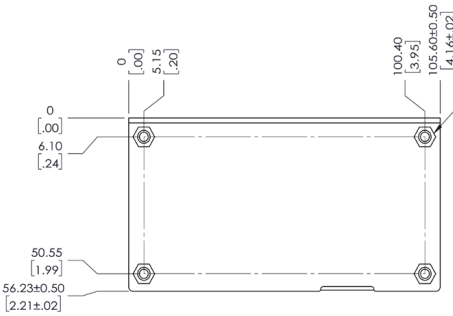
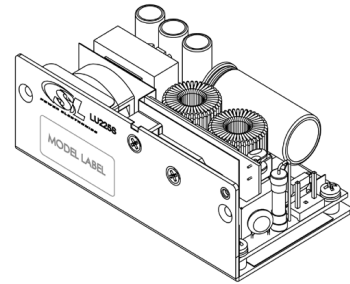
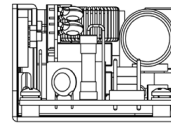
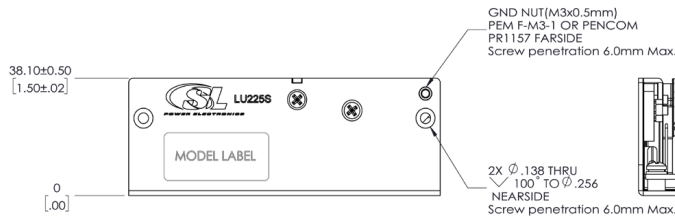

NOTES: Unless otherwise specified.

ASSEMBLY AND PARTS ARE ROHS COMPLIANT.

MAXIMUM GND SCREW(M3.0x0.5MM) PROTRUSION FROM OUTSIDE SURFACE IS 6.0mm [.236 INCH].  
MAXIMUM TORQUE IS 0.55 N.m [5 IN.LB].

Long Version KL

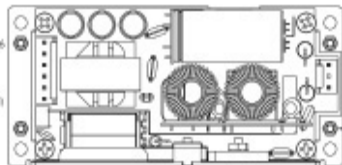

CONNECTOR INFORMATION			
INPUT (J1)		MATING CONNECTOR Tyco/AMP 640250-3 Terminals: 3-640252-1	CONFIGURATION #1 AC NEUTRA #2 EMPTY #3 AC LINE
OUTPUT (J3)		MATING CONNECTOR AMP 640250-6 Terminals: 3-640252-1	CONFIGURATION Pin 1 -Vout Pin 2 -Vout Pin 3 -Vout Pin 4 +Vout Pin 5 +Vout Pin 6 +Vout

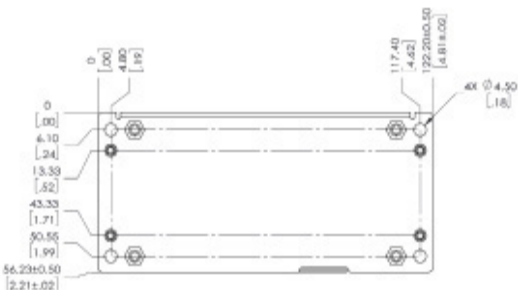
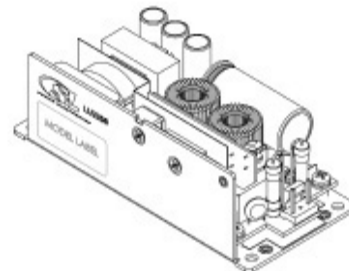
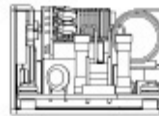

NOTES: Unless otherwise specified.

ASSEMBLY AND PARTS ARE ROHS COMPLIANT.

MAXIMUM GND SCREW(M3.0x0.5MM) PROTRUSION FROM OUTSIDE SURFACE IS 6.0mm [.236 INCH].  
MAXIMUM TORQUE IS 0.55 N.m [5 IN.LB].

EFFICIENCY CURVES

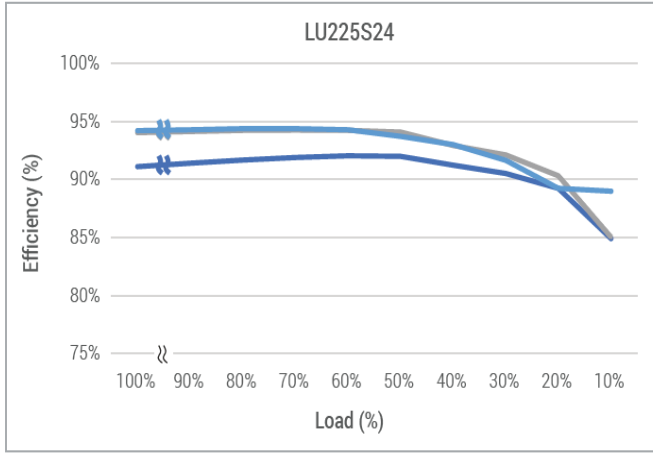

	115Vac
	230Vac
	300Vac

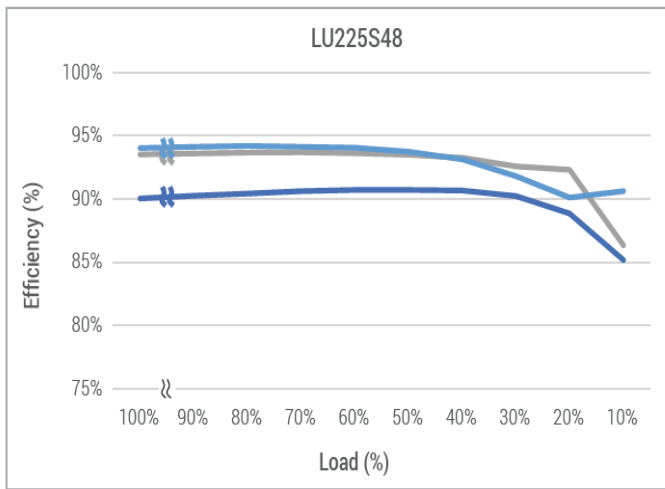

	115Vac
	230Vac
	300Vac

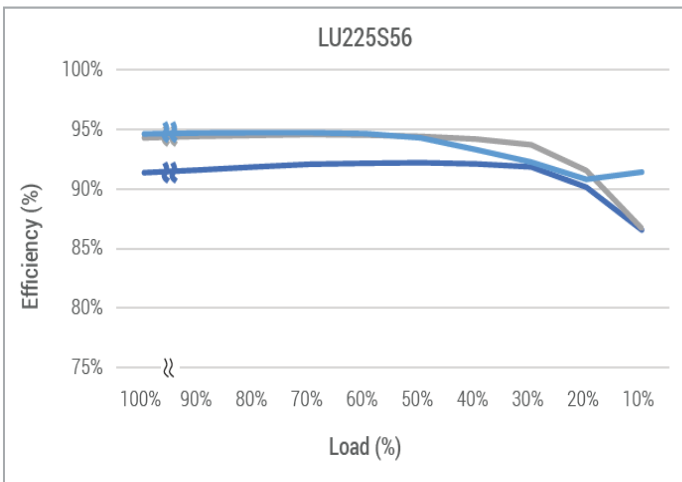

	115Vac
	230Vac
	300Vac

POWER RATING CURVES

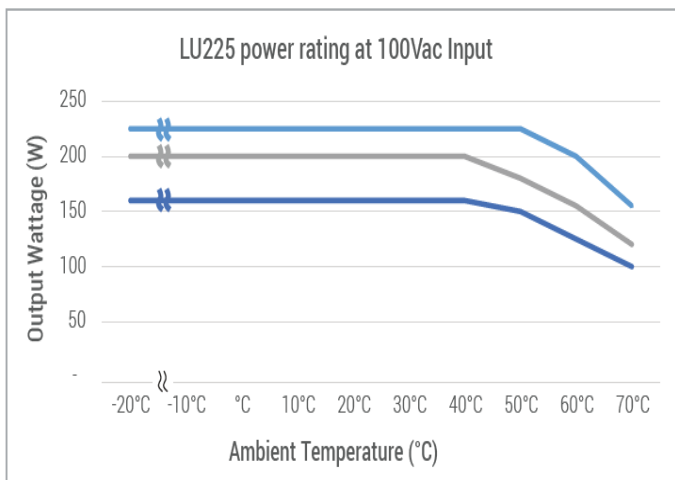

	Convection
	Conduction
	Air Cooling

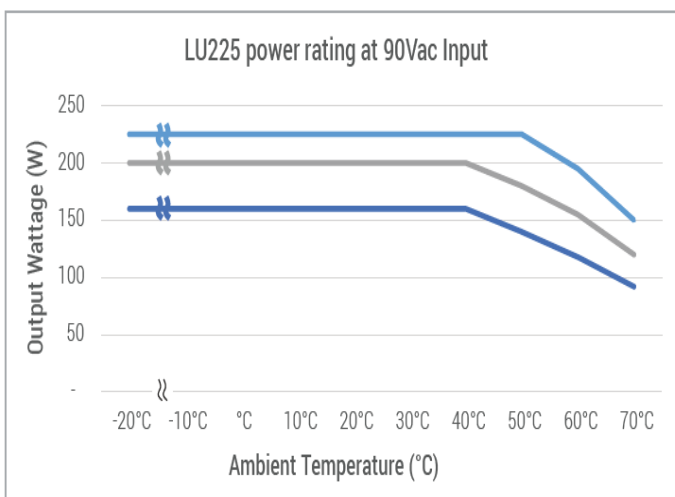

	Convection
	Conduction
	Air Cooling

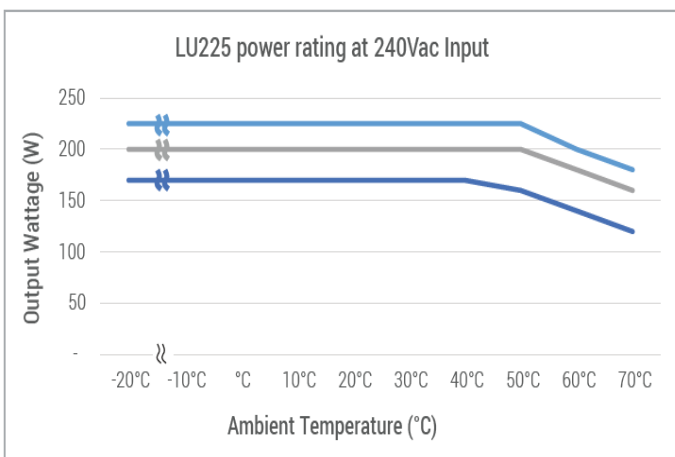

	Convection
	Conduction
	Air Cooling



For international contact information,  
visit [advancedenergy.com](https://www.advancedenergy.com).

[powersales@aei.com](mailto:powersales@aei.com) (Sales Support)  
[productsupport.ep@aei.com](mailto:productsupport.ep@aei.com) (Technical Support)  
+1 888 412 7832

## ABOUT ADVANCED ENERGY

Advanced Energy (AE) has devoted more than three decades to perfecting power for its global customers. AE designs and manufactures highly engineered, precision power conversion, measurement and control solutions for mission-critical applications and processes.

Our products enable customer innovation in complex applications for a wide range of industries including semiconductor equipment, industrial, manufacturing, telecommunications, data center computing, and medical. With deep applications know-how and responsive service and support across the globe, we build collaborative partnerships to meet rapid technological developments, propel growth for our customers, and innovate the future of power.

**PRECISION | POWER | PERFORMANCE | TRUST**

---

Specifications are subject to change without notice. Not responsible for errors or omissions. ©2023 Advanced Energy Industries, Inc. All rights reserved. Advanced Energy®, and AE® are U.S. trademarks of Advanced Energy Industries, Inc.