

RACK 1500 XR Series

Programmable DC Power Supplies

User Manual



1 SAFETY SUMMARY

SAFETY SUMMARY

The following safety precautions apply to both operating and maintenance personnel and must be observed during all phases of operation, service, and repair of this instrument. Before applying power, follow the installation instructions and become familiar with the operating instructions for this instrument.

Failure to comply with these precautions or with specific warnings elsewhere in this manual violates safety standards of design, manufacture, and intended use of the instrument. Versatile Power assumes no liability for a customer's failure to comply with these requirements.

GROUND THE INSTRUMENT

To minimize shock hazard, the instrument chassis and cabinet must be connected to an electrical ground. This instrument is grounded through the ground conductor of the supplied, three-conductor AC power cable. The power cable must be plugged into an approved three-conductor electrical outlet. Do not alter the ground connection. Without the protective ground connection, all accessible conductive parts (including control knobs) can render an electric shock. The power jack and mating plug of the provided power cable meet IEC, UL, and CSA safety standards.

POWER CONNECTION

For pluggable equipment, the socket-outlet shall be easily accessible.

DO NOT OPERATE IN AN EXPLOSIVE ATMOSPHERE

Do not operate the instrument in the presence of flammable gases or fumes. Operation of any electrical instrument in such an environment constitutes a definite safety hazard.

KEEP AWAY FROM LIVE CIRCUITS

Instrument covers must not be removed by operating personnel. Component replacement must only be made by qualified maintenance personnel. Removal of the cover will void the warranty. Under certain conditions, even with the power cable removed, dangerous voltages may exist. To avoid injuries, always disconnect power and discharge circuits before touching them.

DO NOT SERVICE OR ADJUST ALONE

Do not attempt any internal service. This unit contains no user serviceable components. Removal of the cover will void the warranty.

DO NOT SUBSTITUTE PARTS OR MODIFY THE INSTRUMENT

Do not install substitute parts or perform any unauthorized modifications to this instrument. Return the instrument to Versatile Power for service and repair to ensure that safety features are maintained.

RÉSUMÉ DES PRÉCAUTIONS DE SÉCURITÉ

Les précautions de sécurité suivantes s'appliquent au personnel en charge de la maintenance et des opérations, et elles doivent être observées pendant toutes les phases d'utilisation, de maintenance et de réparation de cet appareil. Avant de mettre l'appareil sous tension, suivez les instructions relatives à l'installation et familiarisez-vous avec les instructions d'utilisation de cet appareil.

Le non-respect de ces précautions de sécurité ou des avertissements spécifiques contenus ailleurs dans le présent manuel constitue une violation des normes sécuritaires de conception, de fabrication et d'utilisation prévue de cet appareil. Versatile Power décline toute responsabilité au cas où un client ne respecte pas les présentes exigences.

MISE À LA TERRE DE L'APPAREIL

Afin de réduire les risques de choc électrique, le châssis et l'enveloppe de l'appareil doivent être connectés à une mise à la terre électrique. L'appareil est mis à la terre à travers le conducteur de terre du câble d'alimentation c.a. à trois fils fourni. Le câble d'alimentation doit être branché dans une prise électrique à trois fils approuvée. Ne modifiez pas la connexion de mise à la terre. En l'absence de la connexion de mise à la terre de protection, toutes les parties conductrices accessibles (y compris les boutons de commande) peuvent produire un choc électrique. La fiche d'alimentation et la contre-fiche du câble d'alimentation fourni sont conformes aux normes de sécurité CEI.

CONNEXION DE PUISSANCE

Pour les équipements enfichables, la prise de courant doit être facilement accessible.

NE PAS UTILISER L'APPAREIL DANS UNE ATMOSPHÈRE EXPLOSIVE

N'utilisez pas l'appareil en présence de gaz ou fumées inflammables. L'utilisation d'un appareil électrique dans un tel environnement représente un danger réel pour la sécurité.

MAINTENIR L'APPAREIL ÉLOIGNÉ DE CIRCUITS SOUS TENSION

Le personnel exploitant ne doit pas enlever les capots de l'appareil. Le remplacement des pièces doit être effectué uniquement par un personnel de maintenance qualifié. Le retrait de tout capot annule la garantie. Dans certaines conditions, même lorsque le câble d'alimentation est retiré, des tensions dangereuses peuvent exister. Pour éviter les risques de blessures, débranchez toujours les circuits avant de les manipuler.

NE PAS EFFECTUER LA MAINTENANCE DE L'APPAREIL OU LE RÉGLER SEUL

N'entreprenez pas de réparer les éléments internes. L'appareil ne contient aucun composant pouvant être réparé par l'utilisateur. Le retrait de tout capot annule la garantie.

NE PAS REMPLACER LES PIÈCES OU NE PAS MODIFIER L'APPAREIL

Ne changez pas les pièces ou n'apportez aucune modification non autorisée à cet appareil. Retournez l'appareil à Versatile Power pour la maintenance et les réparations pour vous assurer que les dispositifs de sécurité sont maintenus.

2 WARNINGS AND CAUTIONS

WARNING and **CAUTION** statements, such as the following examples, denote a hazard and appear throughout this manual. Follow all instructions contained in these statements.

A **WARNING** statement calls attention to an operating procedure, practice, or condition, which, if not followed correctly, could result in injury or death to personnel.

A **CAUTION** statement calls attention to an operating procedure, practice, or condition, which, if not followed correctly, could result in damage to or destruction the product.

WARNING: *Do not alter the ground connection. Without the protective ground connection, all accessible conductive parts (including control knobs) can render an electric shock. The power jack and mating plug of the power cable meet IEC, UL, and CSA safety standards.*

WARNING: *Removing the instrument cover and/or replacing any internal components will void the warranty of the instrument unless it is done by an authorized service technician.*

CAUTION: *Before connecting the line cord to the AC mains, check the top cover AC line voltage ratings. Applying a line voltage other than the indicated voltage can damage the unit. For continued protection, replace fuses only with those of the exact same voltage and current ratings.*

CAUTION: *This product uses components which can be damaged by electro-static discharge (ESD). To avoid damage, be sure to follow proper procedures for handling, storing and transporting parts and subassemblies which contain ESD-sensitive components.*

 **CAUTION:** *This equipment produces high power and is to be used only by an instructed or skilled person.*

AVERTISSEMENTS ET MISES EN GARDE

Les énoncés **AVERTISSEMENTS** et **MISES EN GARDE**, notamment les exemples suivants, indiquent un danger et apparaissent tout au long de ce manuel. Suivez toutes les instructions contenues dans ces énoncés.

L'énoncé **AVERTISSEMENT** attire l'attention sur une procédure d'utilisation, une pratique ou une condition, qui, si elle n'est pas correctement suivie, pourrait causer des blessures ou la mort.

L'énoncé **MISE EN GARDE** attire l'attention sur une procédure d'utilisation, une pratique ou une condition, qui, si elle n'est pas correctement suivie, pourrait causer des blessures ou la mort.

AVERTISSEMENT : *Ne modifiez pas la connexion de mise à la terre. Sans la connexion de mise à la terre de protection, toutes les parties conductrices accessibles (y compris les boutons de commande) peuvent produire un choc électrique. La fiche d'alimentation et la contre-fiche du câble d'alimentation fourni sont conformes aux normes de sécurité CEI.*

AVERTISSEMENT : *Le retrait des capots de l'appareil et/ou le remplacement d'un composant interne annulent la garantie de l'appareil, à condition que cela soit effectué par un technicien autorisé.*

MISE EN GARDE : *Avant de brancher le câble d'alimentation au courant de secteur c.a., vérifiez les tensions nominales des lignes c.a. du capot supérieur. L'application d'une tension de ligne autre que la tension indiquée peut endommager l'appareil. Pour une protection continue, remplacez les fusibles uniquement avec des fusibles ayant les mêmes tension et courant nominaux.*

MISE EN GARDE : *Cet appareil utilise des composants pouvant être endommagés par des décharges électrostatiques (DES). Pour éviter tout dégât, suivez les procédures appropriées pour la manutention, le stockage et le transport des pièces et des sous-ensembles contenant des éléments sensibles aux DES.*

 **MISE EN GARDE** : *Cet appareil produit une puissance élevée et doit être utilisé uniquement par une personne instruite ou qualifiée.*

3 STORE/MOVE/MAINTAIN

Storage

When this power supply is not in use store it in an environment suitable for storage (see specifications page).

Freight

When shipping this power supply, repack it in the original packaging. If the packaging material is lost, use equivalent packing materials to protect it during shipping.

Maintenance

Please return the power supply to Versatile Power or an authorized service center for any repair, service, or maintenance.

Disposal

When the power supply is in an unusable condition and can't be repaired, please discard it according to your company's disposal procedures or local legal procedures. To avoid polluting the environment, please do not discard arbitrarily.

CONTENTS

| | | |
|-----|--|----|
| 1 | SAFETY SUMMARY | ii |
| 2 | WARNINGS AND CAUTIONS | iv |
| 3 | STORE/MOVE/MAINTAIN..... | vi |
| 4 | PREFACE | 1 |
| 4.1 | Product Summary | 1 |
| 4.2 | Features | 1 |
| 4.3 | Specifications..... | 2 |
| 5 | CAUTIONS BEFORE USING | 4 |
| 5.1 | Check and Confirm Accessories before Using | 4 |
| 5.2 | Operating Instructions | 4 |
| 5.3 | Ambient Environment | 4 |
| 5.4 | Storage..... | 4 |
| 5.5 | Power-line voltage..... | 5 |
| 5.6 | Fuses..... | 5 |
| 5.7 | Power-off procedure | 5 |
| 5.8 | Low Voltage Input..... | 5 |
| 5.9 | Output Lead Wires and Connections..... | 6 |
| 6 | PRÉCAUTIONS AVANT UTILISATION | 7 |
| 6.1 | Vérifier et confirmer les accessoires avant utilisation..... | 7 |
| 6.2 | Instructions d'utilisation..... | 7 |
| 6.3 | Milieu ambiant | 7 |
| 6.4 | Stockage | 7 |
| 6.5 | Tension secteur | 8 |
| 6.6 | Fusibles | 8 |
| 6.7 | Procédure de coupure d'alimentation..... | 8 |
| 6.8 | Entrée Basse Tension..... | 8 |
| 6.9 | Sortie de Fils de Connexion et Connecteurs | 9 |
| 7 | USER INTERFACE AND CONNECTIONS..... | 10 |
| 7.1 | Front and Rear Details..... | 12 |

| | | |
|-------|---|----|
| 8 | OPERATING INSTRUCTIONS | 14 |
| 8.1 | Normal Operation..... | 14 |
| 8.1.1 | Power On | 14 |
| 8.1.2 | Enabling Output..... | 14 |
| 8.1.3 | Adjusting Voltage and Current..... | 15 |
| 8.1.4 | Displaying Set Points..... | 16 |
| 8.1.5 | Adjusting Over Voltage, Over Current and Over Power Protection..... | 16 |
| 8.2 | Power Supply Setup..... | 18 |
| 8.2.1 | Introduction | 18 |
| 8.2.2 | Mode..... | 20 |
| 8.2.3 | Auto Start Setup..... | 22 |
| 8.2.4 | Remote Sense Setup..... | 25 |
| 8.2.5 | Power Limit Setup | 28 |
| 8.2.6 | Over Limits | 29 |
| 8.2.7 | LAN setup | 32 |
| 8.2.8 | Series and parallel operation | 33 |
| 8.2.9 | Calibration | 36 |
| | APPENDIX A – ANALOG CONTROL INPUTS | 41 |
| | APPENDIX B – USB CONTROL INPUT..... | 42 |
| | APPENDIX C – COMMUNICATING OVER LAN | 47 |
| | APPENDIX D – ERROR MESSAGES..... | 49 |
| | SERVICE INFORMATION..... | 54 |
| | LIMITED THREE YEAR WARRANTY..... | 55 |

4 PREFACE

4.1 Product Summary

Versatile Power RACK 1500 *XR* series is a programmable DC power supply with single output that offers a maximum power output up to 1500 watts. With 12-bit D/A & A/D converters embedded, the power supplies come with the capability of reporting voltage and current very accurately.

The RACK series provides convenient digital rotary control knobs for voltage and current adjustment. The RACK 1500 *XR* series power supplies also come standard with rear ports that allow remote control via USB, Ethernet, and analog control inputs. The USB and Ethernet inputs are SCPI compliant and have LabView drivers available on the National Instruments website or the Versatile Power website at: <https://versatilepower.com/drivers/>. See Appendix B and Appendix C for details. The Rack 1500 *XR* series is also LXI certified, details for using this interface can be found in the Rack 1500 *XR* Programming Manual.

Rack 1500 *XR* supplies also contain a sophisticated scripting ability that allow the user to write programs then load them into the power supply. The power supply can then execute the programs on command by the user. The scripting manual can be found at the Versatile Power website at: <https://versatilepower.com/user-manuals/>.

4.2 Features

1) Output Voltage & Current

| MODEL | VOLTAGE | CURRENT | Power |
|-----------------------|---------|---------|-------|
| RACK 30-70 <i>XR</i> | 30 | 70 | 1500 |
| RACK 50-40 <i>XR</i> | 50 | 40 | |
| RACK 100-20 <i>XR</i> | 100 | 20 | |
| RACK 200-10 <i>XR</i> | 200 | 10 | |
| RACK 400-5 <i>XR</i> | 400 | 5 | |

Note: Output power will be limited to 1100 watts for input voltages of less than 110 VAC.

2) Rotary knob

The digital rotary knobs allow both fine and rapid adjustment of the output voltage and current. The knobs are velocity sensitive so that a slow turn of the knob allows fine adjustment of voltage or current and rapid turning of the knob quickly adjusts voltage or current over a large range.

3) Precise voltage and current measurement

Besides the precise output, the RACK 1500 *XR* series also offers the capability to measure voltage & current accurately (read back), saving users the extra expense and space for extra measuring instruments. This capability is available from the display or the readings may be read into the controlling device.

4) OVP (over voltage protection), OCP (over current protection) and OPP (over power protection) functions

The over voltage protection (OVP), over current protection (OCP) and over power protection (OPP) features limit the maximum output current and voltage to avoid damage to the unit under test (UUT).

4.3 Specifications

Unless otherwise noted, specifications are warranted over the ambient temperature range of 0 to 40 °C after 30 minute warm up.

| | | 30-70 XR | 50-40 XR | 100-20 XR | 200-10 XR | 400-5 XR |
|--|---------------------|--|---------------|----------------|----------------|----------------|
| DC output ratings ^{2,3,10,11} | Voltage | 30 V \equiv | 50 V \equiv | 100 V \equiv | 200 V \equiv | 400 V \equiv |
| | Current | 70 A | 40 A | 20 A | 10A | 5 A |
| | Power ¹⁰ | 1500 W | 1500 W | 1500 W | 1500 W | 1500 W |
| Output ripple and noise | CV p-p ⁴ | 45mV | 75mV | 100mV | 200mV | 300mV |
| | CV rms ⁵ | 10mV | 20mV | 40mV | 80mV | 100mV |
| Load regulation (change from 10% to 90% load) ¹ | Voltage | 0.05% | 0.05% | 0.05% | 0.05% | 0.05% |
| | Current | 0.05% | 0.05% | 0.1% | 0.05% | 0.05% |
| Line regulation (change from 100 to 132 VAC input or 180 to 260 VAC input) ¹ | Voltage | 0.05% | 0.05% | 0.05% | 0.05% | 0.05% |
| | Current | 0.05% | 0.05% | 0.05% | 0.05% | 0.05% |
| Programming accuracy ¹ | Voltage | 0.10% | 0.15% | 0.10% | 0.10% | 0.10% |
| | Current | 0.2% | 0.15% | 0.15% | 0.15% | 0.15% |
| Measurement Accuracy ¹ | Voltage | 0.10% | 0.15% | 0.10% | 0.10% | 0.10% |
| | Current | 0.2% | 0.15% | 0.15% | 0.15% | 0.15% |
| Transient recovery time ⁶ | Time | ≤1.5ms | ≤1.5ms | ≤1.5ms | ≤1.5ms | ≤1.5ms |
| Supplemental Characteristics | | Supplemental characteristics are not warranted but are descriptions of typical performance determined either by design or type testing | | | | |
| Output response time (settle to within ±1% of the rated output, with a resistive load) ⁷ | Up, 10-90% | 15 mS | 30 mS | 25 mS | 30 mS | 35 mS |
| | Down, 90-10% | 25 mS | 25 mS | 25 mS | 45 mS | 40 mS |
| | Down, no load | <2.5S | <3S | <4S | <10S | <10S |
| Command response time ⁸ | | 50 mS | | | | |
| Data readback transfer time ⁹ | | 5 mS | | | | |
| Remote sense compensation | Volts/load lead | 1 V | 1 V | 2 V | 4 V | 4 V |
| Over-voltage protection | Range | 0.5-33 V | 0.5-55 V | 0.5-110 V | 0.5-220 V | 0.5-440 V |
| | Accuracy | .3 V | .5 V | 1 V | 2 V | 4 V |
| Output ripple and noise ⁴ | CC rms | 20 mA | 10 mA | 10 mA | 5 mA | 5 mA |
| Programming resolution and measurement resolution ¹ | Voltage | 0.1% | | | | |
| | Current | 0.1% | | | | |
| Front panel display accuracy ¹ | Voltage | 0.10% | 0.15% | 0.15% | 0.10% | 0.10% |
| | Current | 0.2% | 0.15% | 0.10% | 0.15% | 0.15% |

Notes:

- Rating is percent of full scale. Rating is for operation between 10% of minimum voltage or current rating to 100% of voltage rating and the current rating at that voltage.
- Minimum voltage is guaranteed at greater than 1% of the rated output voltage.
- Minimum current is guaranteed at greater than 1% of the rated output current.
- Measured with 20 MHz bandwidth.
- Line frequency ripple measured with 20 MHz bandwidth (see application note AN024 for measurement details, these measurements taken at full rated output voltage and full power.
- Time for output voltage to recover within 1% of its rated output for a load change from 70 to 100% of its rated output current at full voltage.
- Voltage set point from 10% to 90% of rated output with rated resistive load. When outputting current at or near the set maximum current value, voltage rise time will be longer due to the limited current available to charge the output capacitance.
- Add this to the output response time to obtain the total programming time
- Time to provide data back to the controller using LAN interface (does not include A/D conversion time)
- 1500 watt output is only available with an AC input of 110VAC or greater, with lower AC line output will be limited to 1100W.
- Symbol \equiv indicates DC output

Supplemental Characteristics for All Model Numbers

Series and parallel capability

Parallel operation

Up to 4 units can be connected in master/slave mode

Series operation

Up to 2 units can be connected in series

Output terminal isolation

No output terminal may be more than 600 VDC from any other terminal or chassis ground

Analog programming

(of output voltage and current)

Input signal

Selectable;

0 to 3 V, 0 to 5 V or 0 to 10 V full scale

Input impedance

0 to 10 k Ω full scale

Interface capabilities

USB 2.0

10/100 LAN

Web server

Built-in Web server requires Internet Explorer 5+ or Firefox, or Chrome

LXI

Environmental conditions

Environment

Indoor use, installation category II (AC input), pollution degree 2

Operating temperature

0°C to 40°C @ 100% load

Storage temperature

-20°C to 70°C

Operating humidity

30% to 90% relative humidity (no condensation)

Storage humidity

10% to 95% relative humidity (no condensation)

Altitude

- Up to 3000 meters.
Derate the output current by 2%/100 m above 2000 m.
- Derate the maximum ambient temperature by 1 °C/100 m above 2000 m.

Regulatory compliance

EMC

- European EMC directive 89/336/EEC for Class A products
- This ISM device complies with Canadian ICES-001.
- Cet appareil ISM est conforme a la norme NMB-001 du Canada.

Safety

- European Low Voltage Directive IEC 60950
- US and Canadian safety standards
- Any LEDs used in this product are Class 1 as per IEC 825-1

Acoustic noise declaration

Emission directive:

- Sound pressure Lp <75 dB(A),

At operator position,

*Normal operation, full power

*According to EN 27779 (Type Test).

AC input

Nominal input

100 – 240 VAC; 50/60 Hz

Input current

16 A @ 100 VAC nominal;

8A @ 200 VAC nominal

Input range

100 – 240 VAC; 47 – 63 Hz.

Power factor

>0.95 at nominal input and rated output power

Efficiency

> 85% for 1500 W units at full power out;

Inrush current

<35 A for 1500 W units;

Dimensions

(excluding connectors, control knobs and feet.

Height 44 mm (1.73 in)

Width 483 mm (19 in)

Depth 394 mm (15.5in)

Weight

5.8Kg (12.8 lbs.)

Specifications subject to change without notice.

5 CAUTIONS BEFORE USING

5.1 Check and Confirm Accessories before Using

After receiving this product, please verify the items received in accordance with the ones listed below:

1. The appearance of the product is without scratch or other damage.
2. Standard parts - power supply, power cord.

5.2 Operating Instructions

In order to avoid damaging the instrument due to improper operation, be sure to read this user manual. To maintain the specified accuracy, calibration should be performed annually.

5.3 Ambient Environment

1. Do not locate or operate this product in an environment with dust, vibration, or corrosive gas and do not expose this product directly to the sunlight. Operate it in an environment with temperature 0-40°C and relative humidity 30%-90%. The power supply will sense an over temperature condition and will shut off output power and display an error message should an over temperature occur.

2. This product is equipped with two cooling fans with intake vents on the front, and sides of the chassis and outlet vents on the rear the chassis. Provide at least 1 inch of open space at the vents with good ventilation. If the units are stacked do not block the side air intakes. Never block the rear air outlets.

3. The product is designed with a power line filter to minimize noise into the instrument from the AC power source and to minimize noise output to the line. The power supply is also protected from moderate power transients and ESD on its terminals. If the power supply will be exposed to large transients, external protection should be provided.

5.4 Storage

The storage temperature range of this product is within -20°C to +70°C and R.H. should be 10% to 95% without moisture condensing. If not operating this product for a long time interval, pack it with original packaging or similar one and put it in a dry place without exposure to direct sunlight.

5.5 Power-line voltage

Rated AC power source connected to this product is within 100 - 240 VAC 47 - 63 Hz (refer to the Product Specification for details). Before connecting to external power source, be sure that the power switch is in OFF state and verify that the provided power cord is firmly attached to the power source and to the instrument.

WARNING: The power cable attached with this product is certified for safety. To change a cable or add an extension cable, be sure that it can meet the required power ratings of this product. Any misuse with an additional cable will void the warranty of this product.

5.6 Fuses

This product is a switching mode power supply. The fuse installed is there to protect the power supply in case of excessive input voltage or internal hardware failure. The fuse should not open during normal operation. If the fuse does open, it indicates a malfunction. In this case, it is suggested that the product be sent back for service.

WARNING: If the fuses are replaced they must be replaced with the exact make, model and rating fuse. Failure to do this may cause a safety hazard and may invalidate the warranty.

CAUTION: DOUBLE POLE/NEUTRAL FUSING. Disconnect power before servicing.

5.7 Power-off procedure

When the supply is not in use, be sure to turn the power switch on the panel to the OFF position to turn off the AC power. After the power switch is turned to the OFF position, the inner fans will still run for up to 15 seconds. Once the discharge process is complete, the power supply will shut down.

5.8 Low Voltage Input

When the AC input voltage is lower than the minimum rated voltage which is 90 VAC, the supply will deactivate internal circuitry and will not operate. To ensure proper operation, confirm that the input AC voltage is within the specified range.

5.9 Output Lead Wires and Connections

The RACK 1500 XR series power supply is capable of outputting very high currents and care should be taken to size the output leads and connectors appropriately. Refer to the following table for suggested wire sizes:

| Maximum Current | AWG |
|------------------------|------------|
| 70 | 6 |
| 40 | 8 |
| 20 | 12 |
| 10 | 18 |
| 5 | 22 |

6 PRÉCAUTIONS AVANT UTILISATION

6.1 Vérifier et confirmer les accessoires avant utilisation

Après réception de ce produit, veuillez vous assurer que les articles reçus correspondent à ceux indiqués sur la liste ci-dessous :

1. Les articles ne doivent pas avoir de rayures ou autres dégâts.
2. Pièces standards – alimentation et cordon d'alimentation.

6.2 Instructions d'utilisation

Afin d'éviter d'endommager l'appareil à la suite d'une utilisation inappropriée, veuillez lire le présent manuel d'utilisation. Pour maintenir la précision spécifiée de l'appareil, doit se faire chaque année.

6.3 Milieu ambiant

1. Ne placez pas ou n'utilisez pas ce produit dans un environnement comportant des poussières, sujet aux vibrations ou contenant des gaz corrosifs, et n'exposez pas cet appareil aux rayons directs du soleil. Utilisez cet appareil dans un milieu dont la température est comprise entre 0 et 40°C et dont le taux d'humidité relatif se situe entre 30 % et 90 %. L'alimentation électrique captera toute condition de température excessive et coupera la puissance de sortie. Un message d'erreur s'affichera en cas de température excessive.

2. Ce produit est équipé d'un ventilateur de refroidissement possédant un évent d'admission au-dessus du châssis et des événements de sortie à l'arrière et sur le côté du châssis. Laissez environ 1 pouce d'espace libre au niveau des événements pour une bonne ventilation. Ne bloquez pas les trous de ventilation au-dessus, à l'arrière ou sur le côté de l'appareil, sinon, un avertissement de température excessive pourrait survenir.

3. Ce produit a été conçu avec un filtre de ligne d'alimentation afin d'atténuer le bruit entrant dans l'appareil provenant de la source d'alimentation c.a. et réduire le bruit envoyé vers la ligne. L'alimentation électrique est également protégée des phénomènes transitoires modérés et des surtensions sur ses bornes. Si l'alimentation électrique sera exposée à d'importants courants transitoires, une protection externe doit être prévue.

6.4 Stockage

La plage de température de stockage de ce produit est comprise entre -20°C – 70°C et l'humidité relative (HR) doit être autour de 10 - 95% sans condensation d'humidité. Si vous n'utilisez pas ce produit pendant une longue période de temps, emballez-le avec l'emballage original ou un emballage similaire et entreposez-le dans un endroit sec, à l'abri des rayons directs du soleil.

6.5 Tension secteur

La source d'alimentation c.a. nominale pour ce produit peut être comprise entre 100 V c.a. et 240 V c.a. ; 47-63 Hz (pour de plus amples renseignements, voir les spécifications du produit). Avant de brancher l'appareil à une source d'alimentation externe, assurez-vous que le commutateur d'alimentation est en position d'arrêt « OFF » et vérifiez que le câble d'alimentation fourni est bien branché à la source d'alimentation et à l'appareil.

AVERTISSEMENT : le câble d'alimentation branché à ce produit est certifié conforme aux normes de sécurité. Si vous désirez changer un câble ou ajouter une rallonge, assurez-vous que le nouveau câble ou la rallonge est conforme aux puissances nominales requises pour ce produit. Toute utilisation inappropriée de cet appareil avec un câble supplémentaire annulerait la garantie de ce produit.

6.6 Fusibles

Ce produit est une alimentation à mode de commutation. Le fusible installé a pour but de protéger l'alimentation électrique en cas de tension d'entrée excessive ou d'une défaillance de matériel interne. Le fusible ne doit pas s'ouvrir pendant le fonctionnement normal. Si le fusible s'ouvre, cela indique un dysfonctionnement. Dans ce cas, il est recommandé de retourner le produit pour réparation.

AVERTISSEMENT : si vous devez remplacer les fusibles, les fusibles de rechange doivent être de la même marque, du même modèle et de la même valeur nominale que les fusibles remplacés. Le non-respect de cette précaution peut présenter un danger et invalider la garantie.

MISE EN GARDE : SYSTÈME DE FUSIBLE NEUTRE / À DOUBLE PÔLE. Débranchez l'alimentation avant la réparation.

AVERTISSEMENT : pour assurer une protection continue contre le risque d'incendie, remplacez les fusibles uniquement avec des fusibles de type Littlefuse 0216010.MXP de 10 ampères.

6.7 Procédure de coupure d'alimentation

Lorsque vous n'utilisez pas l'alimentation, placez le commutateur d'alimentation fixé sur le panneau en position d'arrêt « OFF » afin de couper l'alimentation c.a. Après avoir mis le commutateur d'alimentation en position arrêt « OFF », les ventilateurs internes continueront de fonctionner pendant environ 10 à 15. Une fois que le processus de décharge est achevé, l'alimentation électrique est interrompue.

6.8 Entrée Basse Tension

Lorsque la tension d'entrée c.a. est inférieure à la tension nominale minimale qui est de 85 V c.a., l'alimentation désactive les circuits internes et s'arrête de fonctionner. Pour assurer un fonctionnement adéquat, assurez-vous que la tension c.a. d'entrée se situe dans la plage précisée.

6.9 Sortie de Fils de Connexion et Connecteurs

Le banc d'alimentation peut fournir une puissance de courant très élevée et il est essentiel de veiller à choisir la taille adéquate des fils de sortie et des connecteurs. Faites référence au tableau suivant pour les tailles de fils suggérés:

| Courant Maximal | AWG |
|------------------------|------------|
| 70 | 6 |
| 40 | 8 |
| 20 | 12 |
| 10 | 18 |
| 5 | 22 |

7 USER INTERFACE AND CONNECTIONS

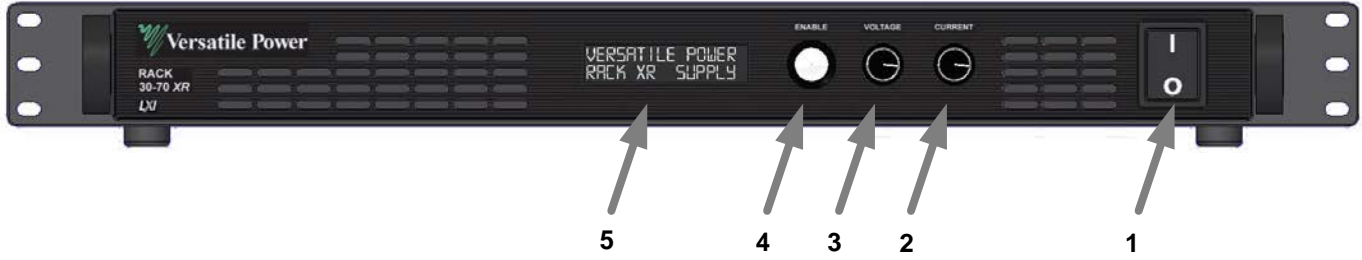

50, 100, 200, & 400 VOLT MODELS

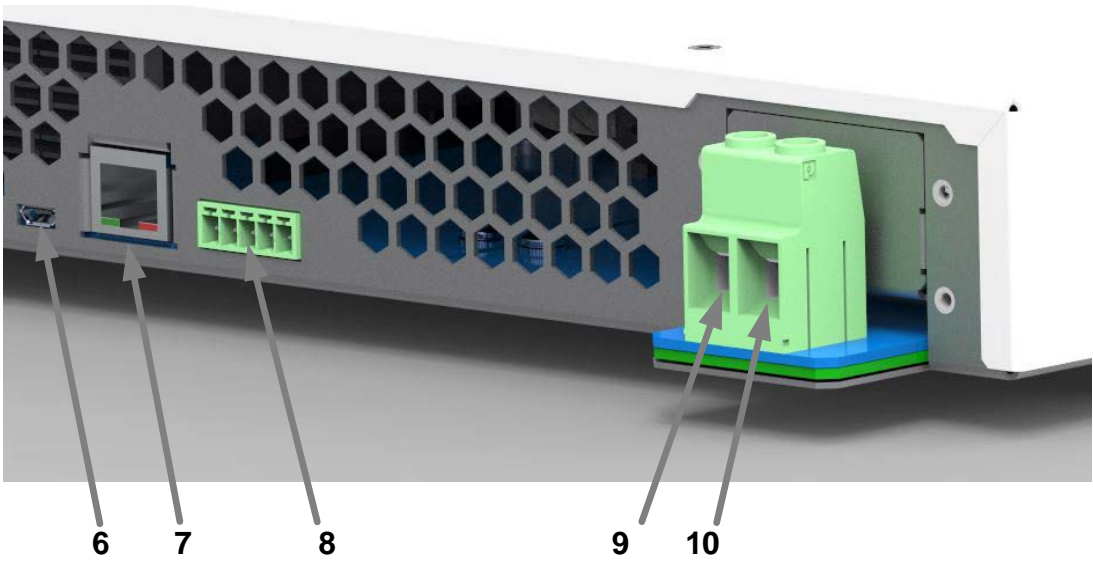

30 VOLT MODEL

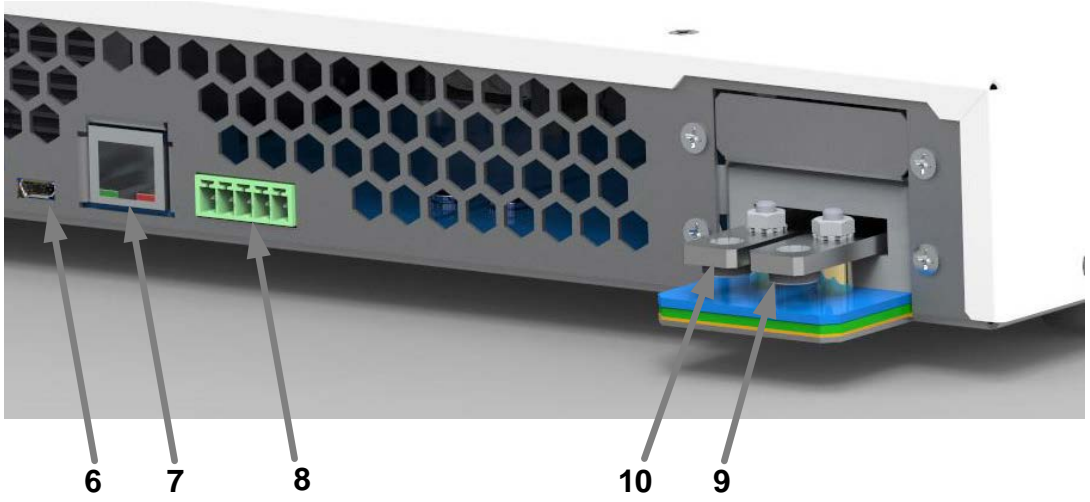



7.1 Front and Rear Details

- (1) Power Switch:
I = ON and O = OFF
Please consult “Cautions Before Using” section before turning on power switch.
- (2) Current Control Knob:
Turn clockwise to increase current limit setting. Turning the knob slowly will increment the least significant digit of the displayed setting. As the knob is turned faster more significant digits will be incremented. When the output is activated pressing this knob will display Set Current.
- (3) Voltage Control Knob:
Turn clockwise to increase voltage limit setting. Turning the knob slowly will increment the least significant digit of the displayed setting. As the knob is turned faster more significant digits will be incremented. When the output is activated pressing this knob will display Set Voltage.
- (4) Enable Pushbutton:
Pushing this button after the power to the power supply has been turned on enables the output voltage. Pressing and holding this button for more than 5 seconds and then releasing will put the power supply into Setup mode. See section 8.2 for setup instructions.

- (5) Display:
16 character by 2 line display. This display shows set points, actual operating values, power supply operating status, error messages, and setup information.
- (6) USB Port:
See Appendix B for use.
- (7) Ethernet Port:
See Appendix C for use.
- (8) Analog Interface:
See Appendix A for use.
- (9) Positive Output
- (10) Negative Output
- (11) AC Input (100-240 VAC)
- (12) Protective Earth

8 OPERATING INSTRUCTIONS

8.1 Normal Operation

8.1.1 Power On

Connect the power input to the appropriate AC voltage source. Turn the Power Switch to the ON (I) position. On power up, the supply will execute a self-test. During the self-test the display will show the voltage and current capabilities of the supply and the software revision.

| |
|-----------------------|
| RACK 1500 XR |
| 100V 15A V1.00 |

8.1.2 Enabling Output

After Power On the output of the power supply will be disabled until the Enable button is pushed. The screen will display the output status, the set points currently in force, and control mode (e.g., Local, Remote).

| | |
|----------------|----------------|
| OFF | LOC |
| V=100.0 | I=3.500 |

Until the Enable button is pressed no power will be available on the output. When the Enable button is pressed the output will be turned on and the display will show the output status, the operating mode, and the actual output voltage and current.

| | | |
|----------------|----------------|------------|
| ON | VMODE | LOC |
| V=100.0 | I=1.654 | |

The power supply will always be in either voltage mode (VMODE) or in current mode (IMODE). This state is dependent on the power supply settings and the load. When in current mode the display will be as shown below.

| | | |
|---------------|----------------|------------|
| ON | IMODE | LOC |
| V=88.2 | I=3.500 | |

To disable the output simply press the Enable button again – this will remove all voltage from the output.

WARNING: Because the power supply has large output capacitors it can take up to 30 seconds for the internal bleeder circuit to fully discharge the output after the Enable button has been pressed to disable the output when there is no load. Hazardous voltages may be present until the output is fully discharged.

AVERTISSEMENT: Étant donné que l'alimentation comporte de grands condensateurs de sortie, le circuit de purge interne peut prendre jusqu'à 30 secondes pour décharger complètement la sortie après avoir appuyé sur le bouton Activer pour désactiver la sortie en l'absence de charge. Des tensions dangereuses peuvent être présentes jusqu'à ce que la sortie soit complètement déchargée.

It is possible to configure the power supply to turn the output on automatically when power is applied. See the Auto Start Setup section ([8.2.3](#)) for further details on this option.

8.1.3 Adjusting Voltage and Current

The voltage and current are set using the two knobs labeled “VOLTAGE” and “CURRENT”. These knobs use high quality digital encoders rather than ordinary potentiometers. Turn the knobs clockwise to increase a setting or counter clockwise to decrease a setting. The encoders allow fine or coarse control of the voltage or current setting. The speed at which you turn the knob will determine the granularity of the setting. Turning at a slow rate will adjust the least most significant digit of the parameter being adjusted. Turning more rapidly allows coarse control to allow rapid changing of voltage or current.

If the output is disabled while an adjustment is being made the voltage and current setting will be shown on the normal output off display. The new settings will take effect when the Enable button is pressed.

If the output is on while an adjustment is being made the voltage or current will change in real time as the knob is turned. A special screen will be displayed during the adjustment as shown below. The screen will revert to the normal operating screen as soon as the adjustment is complete. In the screens below the actual real-time output voltage and current is shown on the bottom line and the set voltage or current is shown in the top line. In the cases below the power supply is current limiting as the actual current matches the set current.

| | |
|---------------|----------------|
| VSET | V=100.0 |
| V=88.2 | I=3.500 |

| | |
|---------------|----------------|
| ISET | I=3.122 |
| V=88.2 | I=3.122 |

Note that the actual voltage or current is load dependent and, therefore, may not match the displayed set point.

8.1.4 Displaying Set Points

At any time during operation, set points can be recalled by pressing the voltage or current adjustment knob. This action displays the set points in the same manner as they would be displayed during a set point adjustment but without actually changing anything. Pressing the voltage knob displays the voltage set point and pressing the current knob displays the current set point.

8.1.5 Adjusting Over Voltage, Over Current and Over Power Protection.

The over voltage protection (OVP), over current protection (OCP) and over power protection (OPP) features limit the maximum output current and voltage to avoid damages to the unit under test (UUT). OVP and OCP may be set as shown below or may be changed via the setup menus. OPP may only be changed in the setup menus. Note that Over Voltage and Over Current protection can also be adjusted in the Setup menu – section [8.2.5](#).

If OVP, OCP, or OPP is set to maximum that protection will be disabled. Note: OVP, OCP, and OPP cannot be set to more than 10% over the maximum rating of the power supply.

To adjust OVP press and release Voltage. The following screen will appear:

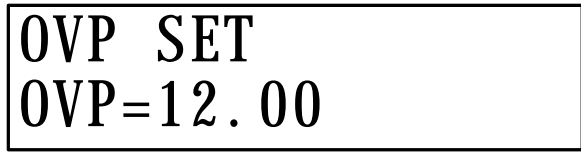

OVP SET
OVP=12.00

Turn the Voltage knob to adjust the OVP setting. When the desired setting is displayed press the Enable button and the supply will revert to its previous state.

To adjust OCP press and release the Current knob. The following screen will appear:

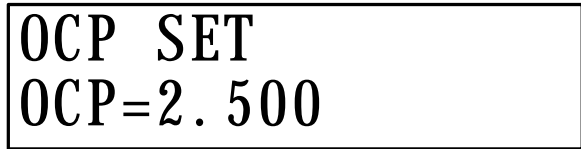

OCP SET
OCP=2.500

Turn the Current knob to adjust the OCP setting. When the desired setting is displayed press the Enable button and the supply will revert to its previous state.

If, during operation, any of these set points is exceeded the appropriate screen will be displayed as below.

8.2 Power Supply Setup

8.2.1 Introduction

Setup mode allows configuration of the power supply. Within setup one can adjust the power on state, select I/O options, enable remote sense, and calibrate the power supply.

To enter setup mode press and hold the enable button for at least 5 seconds. When enabled the initial setup screen will appear.

**SYSTEM SETUP
MODE**

Releasing the Enable button will allow the user to scroll through the setup options by rotating either knob.

SYSTEM SETUP
MODE

SYSTEM SETUP
AUTO-START

SYSTEM SETUP
REMOTE SENSE

SYSTEM SETUP
POWER SETPOINT

SYSTEM SETUP
OVER LIMITS SET

SYSTEM SETUP
LAN CONFIG

SYSTEM SETUP
MASTER MODE

SYSTEM SETUP
CALIBRATION

SYSTEM SETUP
EXIT

8.2.2 Mode

See Appendix A for analog control setup, Appendix B for USB control setup, and the RACK 1500 XR series DC Power Supply USB-Analog Programming Manual for information on serial command syntax and on LXI usage.

8.2.2.1 USB/Analog

The Mode menu allows the user to choose between local control or remote control. If remote control is chosen the user can further select if the control is to be analog voltage control or USB control. The Mode screen shown below is the entry point for these choices.

SYSTEM SETUP
MODE

Rotating either knob clockwise will show the following screens:

MODE
LOCAL

MODE
REMOTE

MODE
ANALOG VOLTAGE

MODE
ANALOG CURRENT

MODE
ANALOG DUAL

MODE
SCRIPT

When the desired mode is displayed press the Enable button to select it. If LOCAL or REMOTE is selected, no further setup is required and the display will return to the setup main menu.

If REMOTE is selected the front panel will be locked out and control will be through the Ethernet port, USB port or analog inputs exclusively.

If ANALOG VOLTAGE is selected, the desired scaling of the analog voltage input must be selected and this screen will appear.

ANALOG FULLSCALE
V=10

Rotating the Voltage knob will allow choice of 3V, 5V or 10V scaling. When the desired option is displayed, press the enable button to select it. The display will return to the setup main menu.

Similarly, ANALOG CURRENT is selected, the desired scaling of the analog current input must be selected and this screen will appear.

ANALOG FULLSCALE
I=10

Rotating the Current knob will allow choice of 3V, 5V or 10V scaling. When the desired option is displayed, press the enable button to select it. The display will return to the setup main menu.

Similarly, ANALOG DUAL is selected, the desired scaling of the analog voltage and current inputs must be selected and this screen will appear.

ANALOG FULLSCALE
V=10 I=10

Rotating the Voltage knob will allow choice of 3V, 5V or 10V scaling for the analog voltage port and rotating the Current knob will allow choice of 3V, 5V or 10V scaling for the analog current port. When the desired option is displayed, press the enable button to select it. The display will return to the setup main menu.

SYSTEM SETUP
MODE

To change another setup item at this time you may use either knob to select that option. To exit setup, rotate either knob until the following screen is displayed then press the enable button.

SYSTEM SETUP
EXIT

The following screen will be displayed.

SAVE CONFIG?
YES

Rotating either knob will alternate between the screen above and the screen below.

SAVE CONFIG?
NO

When the desired option is displayed press the Enable button. Selecting YES will save any Setup changes to non-volatile memory and they will be retained even when primary power is cycled. Selecting NO will not save Setup changes to non-volatile memory and they will be in effect only until the unit is turned off.

The power supply will return to normal operating mode at this time.

8.2.3 Auto Start Setup

The Auto Start option, when enabled, causes the power supply to immediately provide output power when the power switch is turned on without pressing the Enable button. The voltage and current settings will be the same as they were when the supply was last powered off.

WARNING: In Auto Start mode hazardous voltages may be present on the power supply output immediately after power is applied.

When in setup mode rotate either knob until the AUTO-START screen is displayed then press the Enable button. The following screen will be displayed.

AUTO-START?
YES

Rotating either knob will cycle between the yes and no option.

AUTO-START?
NO

When the desired yes or no option is displayed press the Enable button to select it. After selection the following screen will be displayed:

SYSTEM SETUP
AUTO-START

To change another setup item at this time you may use either knob to select that option. To exit setup, rotate either knob until the following screen is displayed then press the enable button.

SYSTEM SETUP
EXIT

The following screen will be displayed.

SAVE CONFIG?
YES

Rotating either knob will alternate between the screen above and the screen below.

SAVE CONFIG?
NO

When the desired option is displayed press the Enable button. Selecting YES will save any Setup changes to non-volatile memory and they will be retained even when primary power is cycled. Selecting NO will not save Setup changes to non-volatile memory and they will be in effect only until the unit is turned off.

The power supply will return to normal operating mode at this time.

8.2.4 Remote Sense Setup

The Remote Sense option, when enabled, allows the power supply to correct for the resistance of any wires and connections between the power supply and the load. Most power supplies with remote sense require a second set of wires between the power supply and the load to sense the voltage at the load. The Versatile Power RACK 1500 XR series supply uses patented technology to digitally compensate for these resistances without the extra sensing wires.

Prior to using the Remote Sense option, a simple load calibration must be performed. This section will detail how to enable Remote Sense and how to do the calibration required.

Once in setup mode rotate either knob until the REMOTE SENSE screen is displayed then press the Enable button. The following screen will be displayed.



A rectangular box containing the text "REMOTE SENSE" on the top line and "ON" on the bottom line, both in a bold, serif font.

Rotating either knob will alternate between the ON or OFF selection. Press the Enable knob when the desired mode is displayed.



A rectangular box containing the text "REMOTE SENSE" on the top line and "OFF" on the bottom line, both in a bold, serif font.

If the NO option is selected the system will revert to the Setup main menu. If the YES option is selected the following screen will be displayed:



A rectangular box containing the text "SHORT LOAD END" on the top line and "OF LOAD WIRES" on the bottom line, both in a bold, serif font.

At this point the load end of the wires must be shorted as shown below:

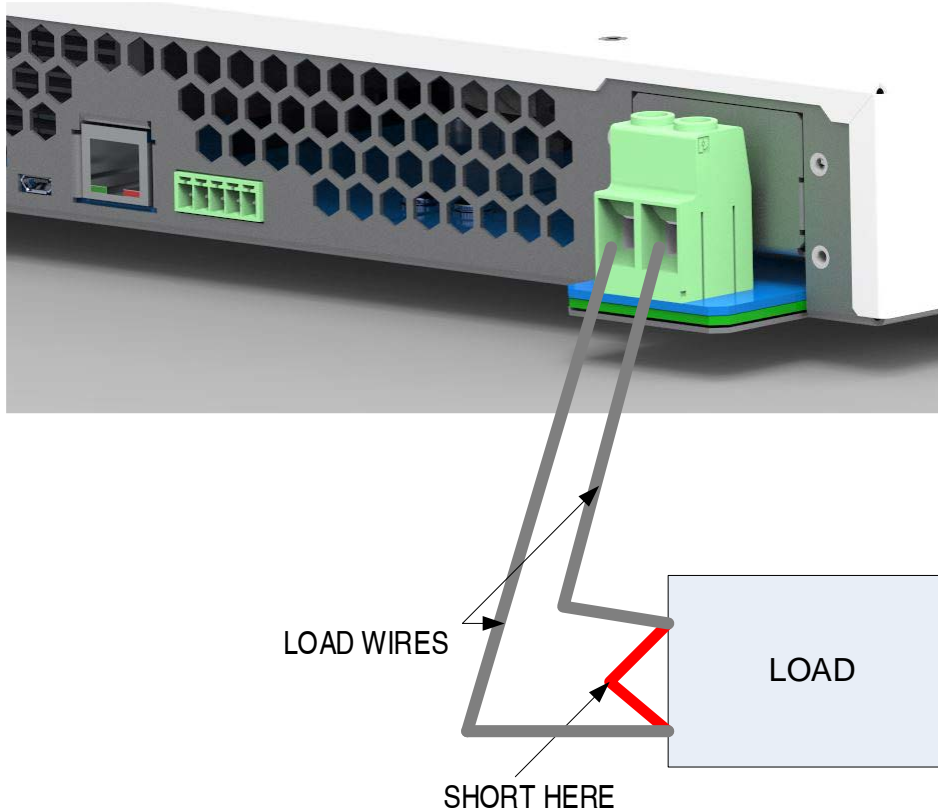

It is important that a good short with heavy wire is made as failure to do this will result in a poor remote sense calibration.

Once the short is in place, press the Enable button. The following screen is an example of what will be displayed.

| |
|--|
| ADJUST TO NORMAL CURRENT $I=2.33$ |
|--|

Now set the current to at least as much as you would expect your load to consume. More is better if your load wires are capable of handling the current. When ready press the Enable button.

The power supply will now measure the output current and the total voltage drop in the load wires and use these values to calculate the resistance of the load wires. As long as Remote Sense remains enabled the power supply will use this resistance value to calculate output voltage based on output current. It will then adjust the output voltage at the power terminals in real time to correct for the drop in the load cables.

If, during the remote sense setup, the lead resistance is so much that remote sense will not be able to operate reliably the following error screen will be displayed.

**LEAD RESISTANCE
TOO GREAT**

The error screen will be followed by:

**REMOTE SENSE
RETRY**

Pressing the enable at this time will bring the user back to the Remote Sense On screen. Remote sense must be turned off or the load wires must be improved to allow calibration of remote sense.

If the remote sense calibration completed normally the display will return to the REMOTE SENSE COMPLETE screen.

**REMOTE SENSE
COMPLETE 99MΩ**

Pressing ENTER will now return the system to the following screen:

**SYSTEM SETUP
REMOTE SENSE**

To change another setup item at this time you may use either knob to select that option. To exit setup, rotate either knob until the following screen is displayed then press the enable button.

**SYSTEM SETUP
EXIT**

The following screen will be displayed.

**SAVE CONFIG?
YES**

Rotating either knob will alternate between the screen above and the screen below.

**SAVE CONFIG?
NO**

When the desired option is displayed press the Enable button. Selecting YES will save any Setup changes to non-volatile memory and they will be retained even when primary power is cycled. Selecting NO will not save Setup changes to non-volatile memory and they will be in effect only until the unit is turned off.

The power supply will return to normal operating mode at this time.

8.2.5 Power Limit Setup

The RACK 1500 XR series of power supplies are designed to supply up to 1500 watts of output power to a load. In some applications it may be desirable to limit the maximum power to something lower than the maximum available from the power supply. This section describes how to set up power limiting.

- 1) Enter setup mode
- 2) Rotate the voltage or current knob until the following screen appears.

**SYSTEM SETUP
POWER SETPOINT**

- 3) Push the select button and the following screen will appear.

**POWER SETPOINT
P=1500W**

- 4) Rotate the voltage or current knob to adjust the maximum power that can be delivered by the supply. This may be in the range of 1% to 101% of the maximum rating (15 watts to 1515 watts for the RACK 1500 XR series).
- 5) When the power is set to the maximum desired power is displayed then press the select button.

Now rotate either knob until the following screen is displayed then press the select button.

**SYSTEM SETUP
EXIT**

6) The following screen will be displayed.

**SAVE CONFIG?
YES**

Rotating either knob will alternate between the screen above and the screen below.

**SAVE CONFIG?
NO**

When the desired option is displayed press the Enable button. Selecting YES will save any Setup changes to non-volatile memory and they will be retained even when primary power is cycled. Selecting NO will not save Setup changes to non-volatile memory and they will be in effect only until the unit is turned off.

The power supply will return to normal operating mode at this time and if you selected Save Config, Yes then the new power limit will be in effect. To remove the power limit the same procedure should be used and the power should be set to 1515 watts.

8.2.6 Over Limits

Over Limits allows the user to set in maximum values for voltage, current, and power that are less than the full power supply rating in cases where there is a desire to protect the load. Note that Overvoltage and Overcurrent protection can be set from the front panel as shown in section [8.1.5](#). To enter Over Limits setup press Enable when the following screen is displayed within the Setup menu.

**SYSTEM SETUP
OVER LIMITS SET**

When Enable is pressed the following screen will appear.

OVP SET
OVP=12.00

This screen allows the adjustment of the Over Voltage trip point. Turn either the voltage or the current knob to adjust the value. Press the Enter button when the value you wish is displayed. When the Enter button is pressed the following screen will be displayed:

OCP SET
OCP=2.500

This screen allows the adjustment of the Over Current trip point. Turn either the voltage or the current knob to adjust the value. Press the Enter button when the value you wish is displayed. When the Enter button is pressed the following screen will be displayed:

OPP SET
OPP=1650

This screen allows the adjustment of the Over Power trip point. Turn either the voltage or the current knob to adjust the value. Press the Enter button when the value you wish is displayed. When the Enter button is pressed the following screen will be displayed:

SYSTEM SETUP
OVER LIMITS SET

To change another setup item at this time you may use either knob to select that option. To exit setup, rotate either knob until the following screen is displayed then press the enable button.

SYSTEM SETUP
EXIT

The following screen will be displayed.

SAVE CONFIG?
YES

Rotating either knob will alternate between the screen above and the screen below.

SAVE CONFIG?
NO

When the desired option is displayed press the Enable button. Selecting YES will save any Setup changes to non-volatile memory and they will be retained even when primary power is cycled. Selecting NO will not save Setup changes to non-volatile memory and they will be in effect only until the unit is turned off.

The power supply will return to normal operating mode at this time.

8.2.7 LAN setup

The RACK 1500 XR series of power supplies comes standard with an Ethernet LAN interface. While in local mode and setup mode the power supply LAN setup data may be viewed. Normally the power supply mode will be used in DHCP mode and an IP address will be provided by the router the supply is connected to. To view the current setup, do the following.

- 1) In setup mode turn a knob until the following screen appears.

**SYSTEM SETUP
LAN CONFIG**

- 2) Press Enable and the following screen will be displayed.

**LAN SETTINGS
CONNECTED**

The above screen will be displayed if the supply is connected to a LAN if the supply is not connected to a LAN the lower line will read NOT CONNECTED.

- 3) Rotate a knob one click and the following screen will be displayed. Note that the IP address displayed will be the one assigned by your router and will not match the address shown below.

**LAN IP ADDRESS:
10.45.45.84**

- 4) Rotating the knob another click will display the MAC address for this supply. This address will not match the one in the example below as every supply has its own unchangeable MAC address.

**LAN MAC ADDRESS:
001EC095E517**

- 5) Rotating the knob one step further will display the following screen.

RESET LAN CONFIG

If you wish to reset the LAN settings to the factory default press the Select button again. Now rotate either knob until the following screen your selection of Yes or No is displayed. Pressing Select once again while Yes is displayed will reset the power supply LAN settings.

This feature is useful if the IP address has been set to a static address and is no longer able to communicate with the LAN.

For **further information** on use and control of the power supply with Ethernet LAN see Appendix C.

8.2.8 Parallel operation

The RACK 1500 XR series of power supplies may be used in parallel combinations.

For both of these modes the power supplies used must be identical models.

WARNING: Output terminal isolation: No output terminal may be more than 600VDC from other terminal or chassis ground.

For parallel operation up to 4 units may be connected in MASTER/SLAVE mode

In order to parallel or series RACK 1500 XR series power supplies one power supply must be set up to be the master and the rest of the power supplies must be set up as slaves. To put a power supply in master mode, do the following steps:

- 1) Enter setup mode.

SYSTEM SETUP
MODE

- 2) Rotate the voltage or current knob until Master Mode screen appears.

SYSTEM SETUP
MASTER MODE

- 3) Press the Enable button then rotate the voltage or current knob to select parallel or series master mode. Press the enable button when the mode you wish is displayed.

MASTER MODE
PARALLEL (I)

- 4) Rotate the voltage or current knob until the Exit screen is displayed

SYSTEM SETUP
EXIT

- 5) Press select and the following screen will be displayed.

SAVE CONFIG?
YES

- 6) Press select again to save the configuration and leave the power supply in master mode

Next, the other power supplies must be put in slave mode to allow them to follow the output of the master supply.

For parallel supplies do the following:

- 1) On all of the slave supplies set the voltage to the maximum voltage that will be desired in the application. Note that this voltage setting on the slaves will not be the actual voltage output. The actual voltage output will be determined by the master. This setting will only determine the *maximum* voltage that will be output by the slave when following the master. All slaves should be set to this same maximum voltage.
- 2) Put the power supply in analog current control mode by doing the following:
 - a. Put the power supply in setup mode

SYSTEM SETUP
MODE

- b. When MODE is displayed press the select button then rotate the voltage or current knob until the following screen is displayed.

MODE
ANALOG CURRENT

- c. Press the Select button

ANALOG FULLSCALE
I = 10

- d. Press the Select button again to choose full scale as a 10 volt input.
- e. Rotate the voltage or current knob until the Exit screen is displayed.

SYSTEM SETUP
EXIT

- f. Press the Select button

SAVE CONFIG?
YES

- g. Press select again to save the configuration and leave the power supply in analog control mode.

- 3) Connect the power supplies together.
 - a. On the analog connector in the back of the unit connect all pins 2 together to tie the analog grounds together.
 - b. Also, on the analog connector in the back of the unit connect pin 5 (Sharing Output) of the master supply to pins 3 (Voltage Control Input) of the slave supply.
 - c. Now connect the all the positive outputs together and all the negative outputs together.

You have now completed setup for parallel operation of the power supplies. When connected to a load, voltage and current will be determined by the master supply. Adjusting the voltage on the master will adjust the outputs on all of the supplies. As the load changes, the current will be shared between all of the supplies. Note that the current setting on the master will reflect the actual current output by the paralleled supplies divided by the number of supplies in parallel.

8.2.9 Calibration

Power supply calibration allows qualified personnel to calibrate the output voltage and current and the displayed voltage and current. The process is very simple but it does require some specialized equipment. The required equipment is a calibrated volt meter and a calibrated current shunt. The current shunt must be rated for at least the full rated output current of the power supply but must not be rated at so high a current that a meaningful reading cannot be obtained at the full rated current of the power supply.

To calibrate the power supply, use the following procedure:

Enter setup mode. Once in setup mode rotate either knob until the CALIBRATE screen is displayed then press the Enable button. The following screen will be displayed.



A rectangular screen with a black border containing the text "CALIBRATE?" on the top line and "YES" on the bottom line, both in a bold, serif font.

Rotating either knob will alternate between the ON or OFF selection. Press the Enable knob when the desired mode is displayed.



A rectangular screen with a black border containing the text "CALIBRATE?" on the top line and "NO" on the bottom line, both in a bold, serif font.

If the NO option is selected the system will revert to the Setup main menu. If the YES option is selected the following screen will be displayed:



A rectangular screen with a black border containing the text "OUTPUT" on the top line and "OPEN LOAD" on the bottom line, both in a bold, serif font.

At this point only a volt meter should be connected to the output. No load should be connected. See illustration below.

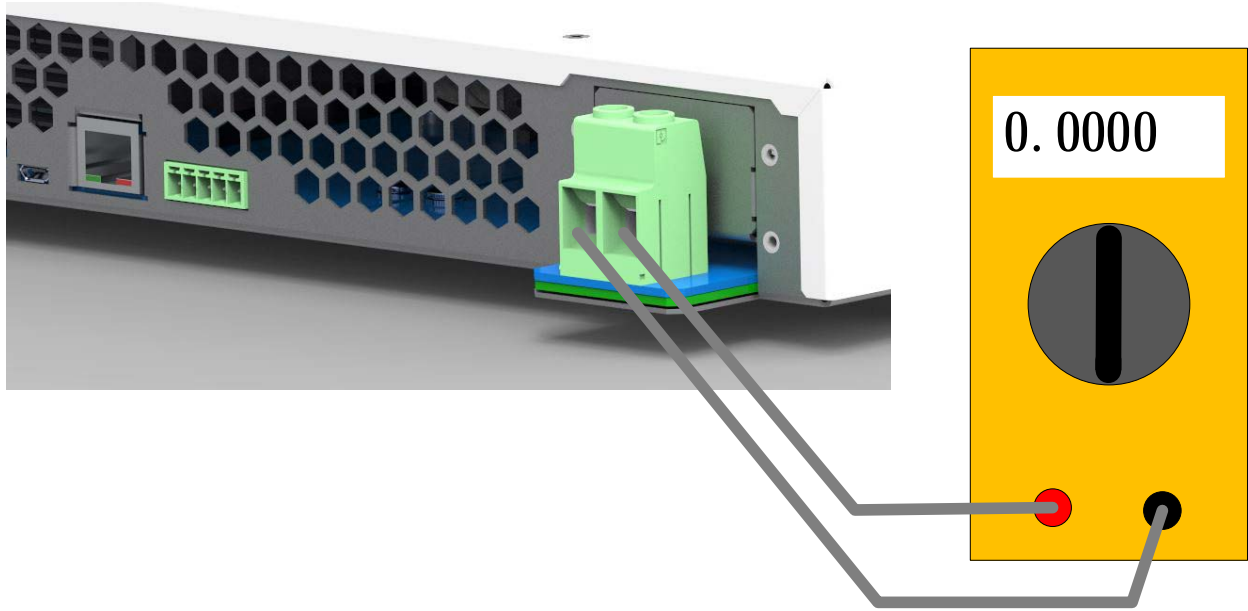

When the volt meter is connected, press the Enable button. The following screen is an example of what will appear.

**SET VOLTAGE TO
10.0 VOLTS**

Now, using the Voltage knob, adjust the output until the external volt meter reads exactly the voltage displayed on the power supply display. Note that the voltage displayed on the screen will vary depending on the power supply model.

When the two voltages match exactly, press the Enable button and the following screen will appear:

**SET VOLTAGE TO
100.0 VOLTS**

Again, using the Voltage knob, adjust the output until the external volt meter reads exactly the voltage displayed on the power supply display. Note that the voltage displayed on the screen will vary depending on the power supply model.

When the two voltages match exactly, press the Enable button and the following screen will appear:

OUTPUT SHORT CIRCUIT

Now a current shunt must be connected across the output and a voltage meter connected to the shunt. Use the figure below for guidance.

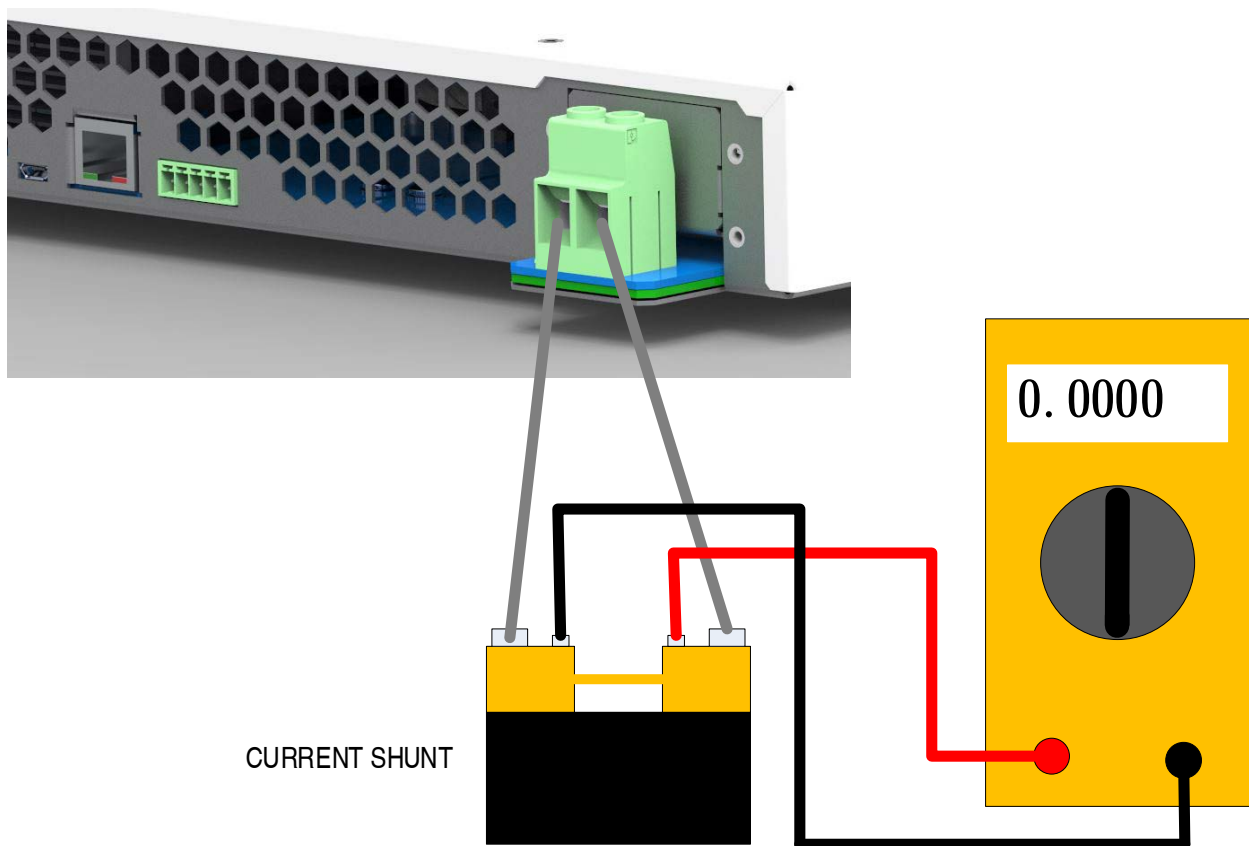

When the power supply is configured as in the figure above, press the Enable button. The following screen will now appear:

**SET CURRENT TO
0.600 AMPS**

Using the Current knob, adjust the output until the external volt meter reads exactly the current displayed on the power supply display. Note that the voltage displayed on the meter will be dependent on the type of current shunt used. The voltage to be adjusted to obtain the correct current must be calculated. For example, a 10 amp, 50mV shunt will drop 50mV with 10 amps of current. The resistance is, therefore, $R = \frac{.050}{10} = 0.005 \text{ ohms}$. So, for the calibration screen shown above the voltage meter should read $V = 0.600 * 0.005 = .003 \text{ volts}$.

Note also that the current displayed on the screen will vary depending on the power supply model.

When the current is exactly correct, press the Enable button and the following screen will appear:

**SET CURRENT TO
6.00 AMPS**

Using the same formula as above, the voltage reading on the volt meter should be 0.030 volts (for this example) when the supply is set correctly.

When the current is exactly correct, press the Enable button and the following screen will appear:

**CALIBRATION
COMPLETE**

Pressing Enable at this point will return you to the Setup main menu.

**SYSTEM SETUP
CALIBRATE**

To change another setup item at this time you may use either knob to select that option. To exit setup, rotate either knob until the following screen is displayed then press the enable button.

SYSTEM SETUP
EXIT

The following screen will be displayed.

SAVE CONFIG?
YES

Rotating either knob will alternate between the screen above and the screen below.

SAVE CONFIG?
NO

When the desired option is displayed press the Enable button. Selecting YES will save any Setup changes to non-volatile memory and they will be retained even when primary power is cycled. Selecting NO will not save Setup changes to non-volatile memory and they will be in effect only until the unit is turned off.

The power supply will return to normal operating mode at this time.

APPENDIX A – ANALOG CONTROL INPUTS

As a standard feature, RACK 1500 XR series power supplies have an analog port that allows remote control. The analog control option allows the use of either 0 - 3 volt inputs, 0 - 5 volt inputs or 0 -10 volt inputs. In addition, there is a 3.0 volt reference source so that external potentiometers can be used as inputs.

The pinout of the Analog control connector is as follows:

| PIN | FUNCTION |
|-----|-----------------------|
| 1 | 3.0 Volt Reference |
| 2 | Ground |
| 3 | Voltage Control Input |
| 4 | Current Control Input |
| 5 | Sharing Output |

The connector physical pinout is shown below. The correct mating connector is an On Shore Technology Inc. 5 pin connector such as their part number OSTTJ0531530.

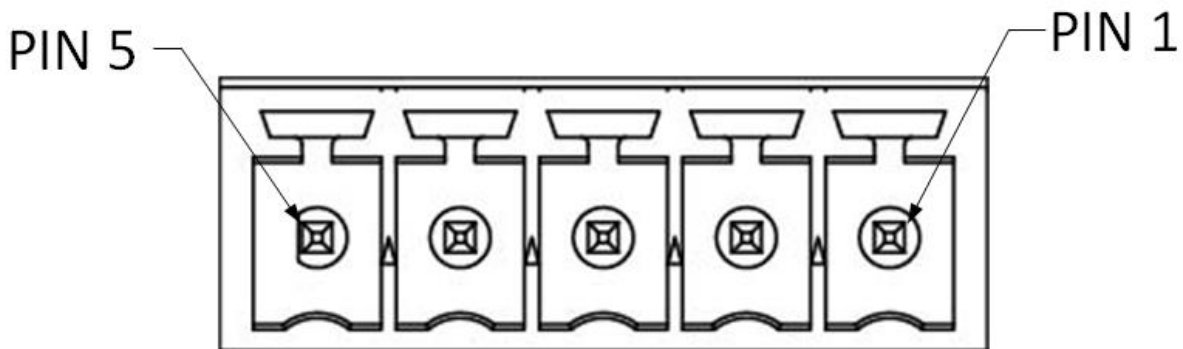

To use a potentiometer as the control source, connect one end of the potentiometer to the 3.0 Volt Reference, the other end to Ground and the wiper to the control Input. The potentiometer should be in the range of 1K to 10K ohms. Set the power supply to run from a 3 volt analog input on voltage or current or both.

CAUTION: Although these inputs are protected from ESD continuous voltages in excess of 5 volts may damage the option card. Also, noise on the inputs can affect the performance of the power supply. For long leads the user should tightly twist the wires together and consider shielding.

ATTENTION: Bien que ces entrées soient protégées contre les décharges électrostatiques, des tensions continues supérieures à 5 volts peuvent endommager la carte optionnelle. De plus, le bruit sur les entrées peut affecter les performances de l'alimentation. Pour de longues dérivations, l'utilisateur doit tordre fermement les fils ensemble et envisager un blindage.

APPENDIX B – USB CONTROL INPUT

USB drivers are available on the Versatile Power website at <https://versatilepower.com/drivers/>. Be sure to download and extract the Bench USB Driver to your local drive. The extraction location will be required in later steps.

The standard USB input is a USB 2.0 full speed compatible USB port.

To install the USB drivers be sure to first make sure the unit is powered on and the Rack unit is connected to the computer's USB port.

Open Device Manager and locate the "RACK XR SUPPLY" under Other devices.

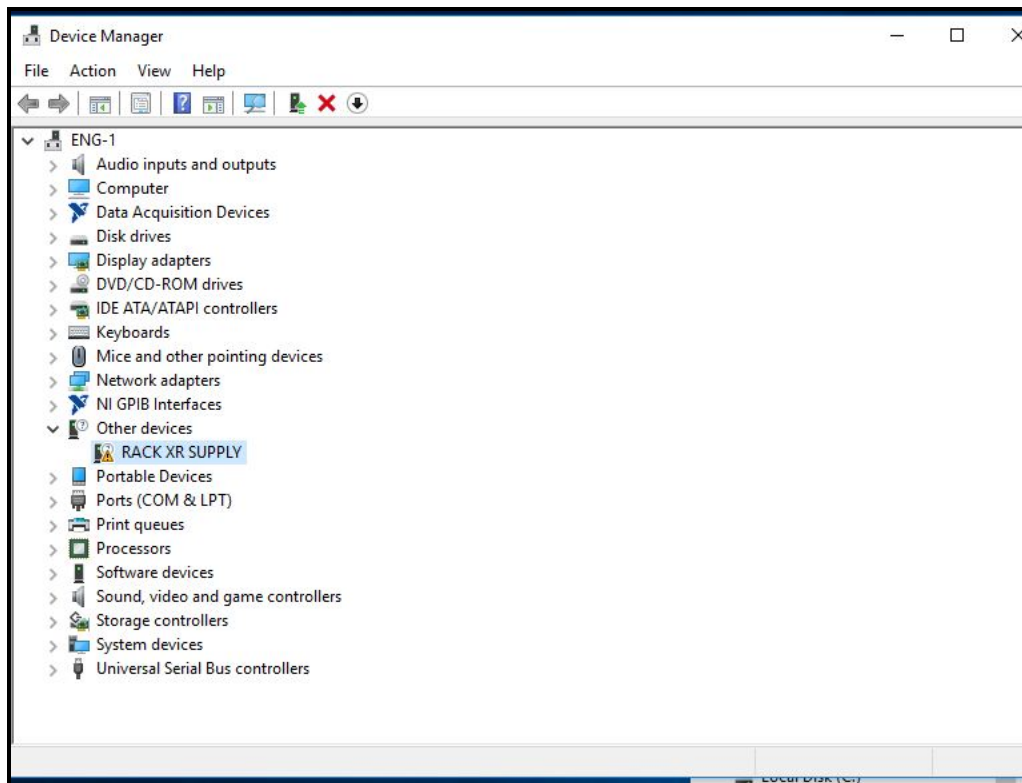

Right click on “RACK XR SUPPLY” and select properties.

On the Driver tab select Update Driver:

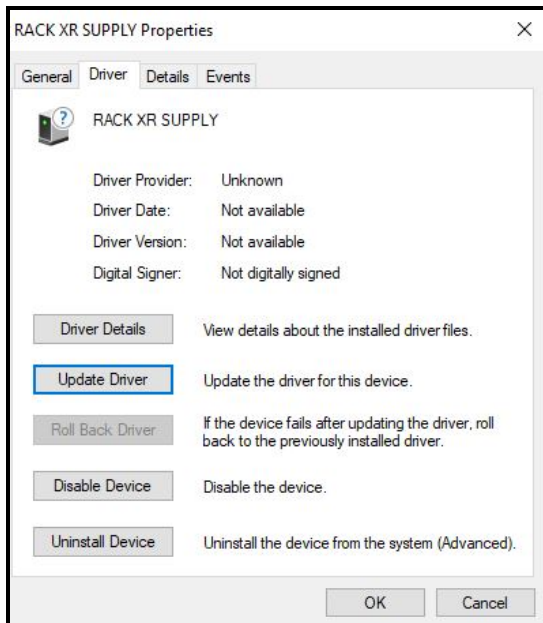

Select Browse my computer for driver software:

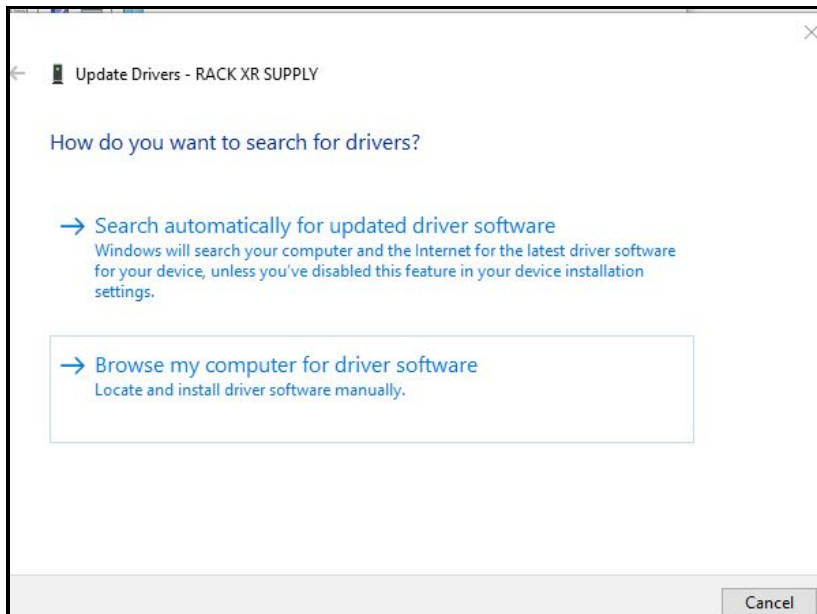

Select Browse...

On the Browse for screen Select RACK XR>USB Driver and press OK

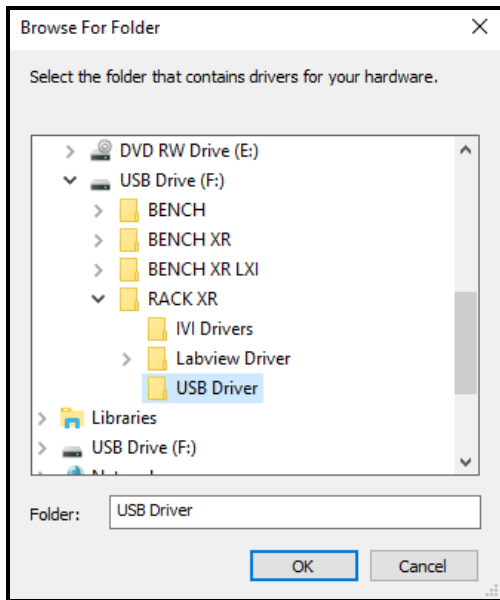

On Windows Security select Install:

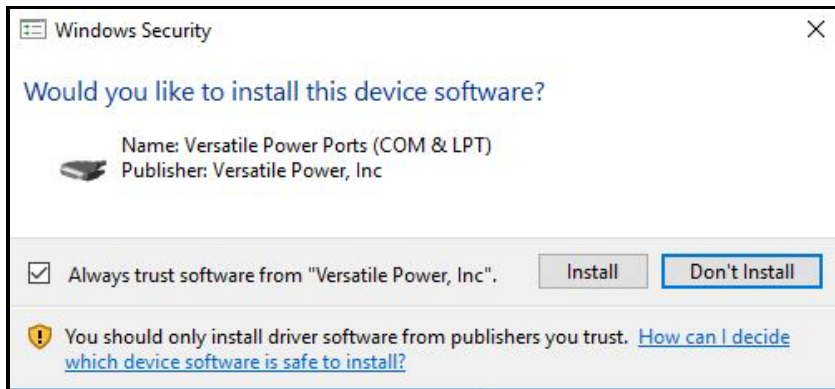

Once the driver has been successfully installed windows will verify the installation and the Rack can now be accessed through USB communication.

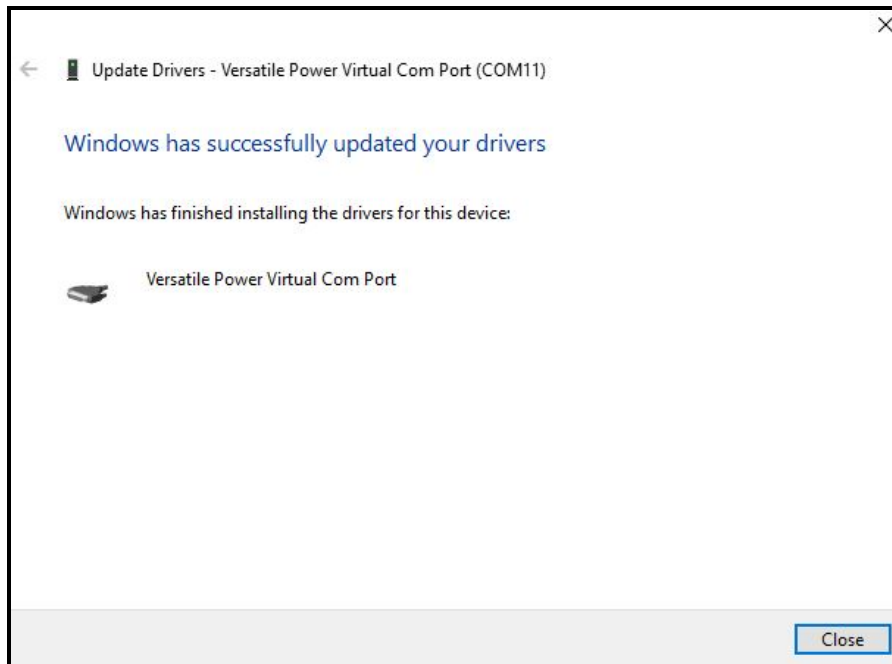

Device manager will show the unit as follows:

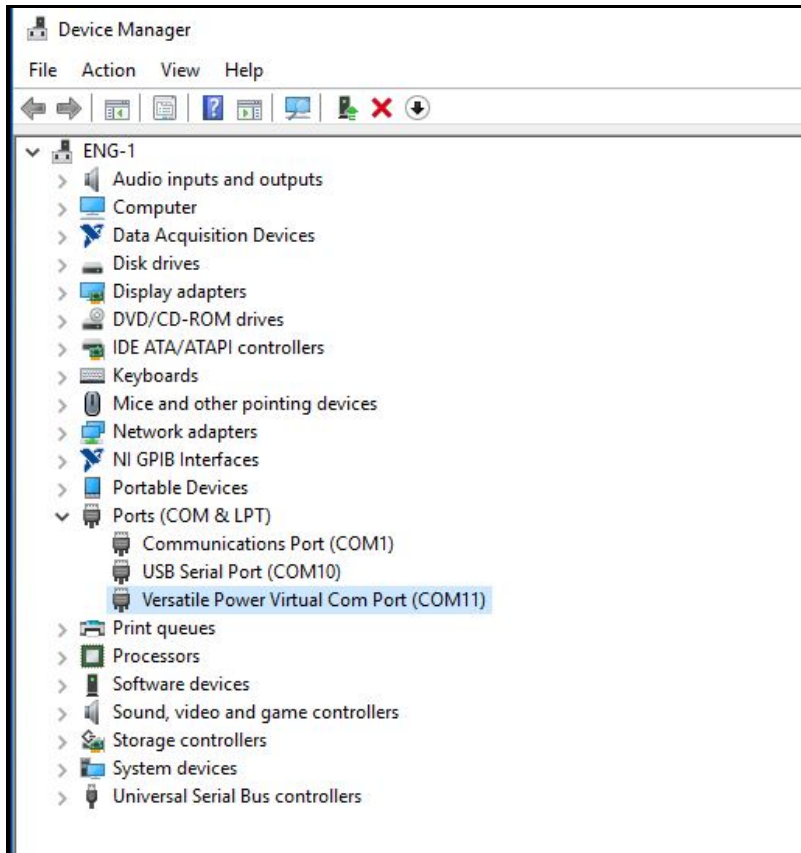

APPENDIX C – COMMUNICATING OVER LAN

You can communicate with your power supply over the LAN connection using a Web server, or using the built in SCPI command set over UDP/IP. These methods are a convenient way to communicate with the power system without using I/O libraries or drivers. In all cases, you must first establish a LAN connection from your computer to the power system as in section 0.

Using the Web Server

Your power system has a built-in Web server that lets you control it directly from an internet browser on your computer. With the Web server, you can access the front panel control functions including the LAN configuration parameters. Up to two simultaneous connections are allowed. With additional connections, performance will be reduced.

NOTE

The built-in Web server only operates over the LAN interface. It requires Internet Explorer 7+ or Firefox2+, or Chrome.

The Web server is enabled when shipped. To launch the Web server:

- 1) Open the internet browser on your computer.
- 2) Obtain the power supplies IP address as described in section 8.2.7. Enter the instrument's IP address into the browser's Address field to launch the Web server.
- 3) You will be asked for a user name and password. The default user name is "admin" and the default password is "password".
- 4) The following home page will appear:

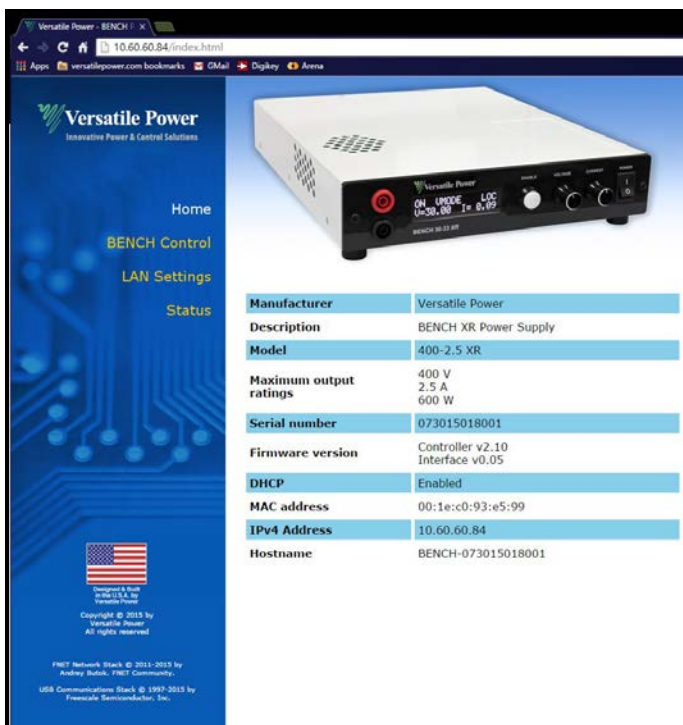

The screenshot shows a web browser window displaying the Versatile Power web interface. The browser address bar shows the URL 10.60.60.84/index.html. The page features a navigation menu on the left with links for Home, BENCH Control, LAN Settings, and Status. The main content area includes a photograph of the BENCH XR Power Supply and a table of device information.

| | |
|------------------------|-------------------------------------|
| Manufacturer | Versatile Power |
| Description | BENCH XR Power Supply |
| Model | 400-2.5 XR |
| Maximum output ratings | 400 V 2.5 A 600 W |
| Serial number | 073015018001 |
| Firmware version | Controller v2.10 Interface v0.05 |
| DHCP | Enabled |
| MAC address | 00:1e:c0:93:e5:99 |
| IPv4 Address | 10.60.60.84 |
| Hostname | BENCH-073015018001 |

- 5) Click on the RACK 1500 XR series Control button to begin controlling your power supply.

If desired, you can control access to the Web server using password protection. As shipped from the factory, the password is "password". To change the password, click on the LAN Settings button.

The power supply is shipped from the factory in DHCP mode so that it will automatically obtain a password from your router. Should you wish to set a static IP address you may do so from the LAN Settings page.

As shipped from the factory you may monitor your power supply using the LAN interface but not control it. In addition, a user may also adjust the power supply settings from the front panel. Should the user wish to control the power supply and lock out the front panel the power supply should be put into remote mode as described below.

- 1) Enter setup mode and then push the Select button on the following screen.



A rectangular box containing the text "SYSTEM SETUP" on the top line and "MODE" on the bottom line, both in a bold, serif font.

- 2) When the following screen is displayed rotate either knob to select REMOTE



A rectangular box containing the text "MODE" on the top line and "LOCAL" on the bottom line, both in a bold, serif font.



A rectangular box containing the text "MODE" on the top line and "REMOTE" on the bottom line, both in a bold, serif font.

- 3) When REMOTE is displayed press the select button. Note that when in remote mode all menu selections other than REMOTE or LOCAL are suppressed.
- 4) Exit and Save the setting.

Controlling your power supply using TCP/IP or UDP/IP

Your power system has built-in TCP/IP and UDP/IP interfaces that allow you to control the power supply using the full supported SCPI command set.

To use either interface use the IP address as set up in previous chapters of this manual and use port 8003 for TCP and 8005 for UDP. Follow each SCPI command with a line feed. A complete description of the SCPI command set is in the supplied Programming Manual.

APPENDIX D – ERROR MESSAGES

This appendix describes the various error conditions that can occur in the power supply. There are two groups of error conditions; first, errors that involve exceeding of limits set by the operator or that are hard programmed into the unit, second, errors involving a failure within the power supply.

The first group of errors – errors caused by limits set by the user or the factory are described below:

OVERCURRENT TRIP ENABLE TO RESET

The “OVERCURRENT TRIP” error is caused by exceeding the current set by the “OCP SET” command. If the current limit value is set to below the “OCP SET” value this condition will rarely if ever occur. If the “OCP SET” value is below the current limit value then this condition will occur whenever the load resistance is low enough to allow the set value to be exceeded without going into voltage. To reset the power supply simply press the ENABLE button.

OVERVOLTAGE TRIP ENABLE TO RESET

The “OVERVOLTAGE TRIP” error is caused by exceeding the voltage set by the “OVP SET” command. If the voltage limit value is set to below the “OVP SET” value this condition will rarely if ever occur. If the “OVP SET” value is below the voltage limit value then this condition will occur whenever the load resistance is high enough to allow the set value to be exceeded without going into current limit. To reset the power supply simply press the ENABLE button.

OVERPOWER TRIP ENABLE TO RESET

The “OVERPOWER TRIP” error is caused by exceeding the power set by the “OPP SET” command. To reset the power supply simply press the ENABLE button.

OVER TEMPERATURE ENABLE TO RESET

The “OVER TEMPERATURE” error is caused by exceeding the maximum operating temperature of the power supply. To reset the power supply simply press the ENABLE button. If the power supply is within its temperature limits when the ENABLE button is pressed the supply will return to normal operation. If the supply is still outside its operating limits the error will persist. If this error reoccurs after a cool down period check to be sure that there is at least one inch of clearance around all the vents.

The second group of errors – errors involving a failure within the power supply are described below:

OUTPUT ERROR ENABLE TO RESET

The “PWM ACTIVATE ERR” error is an internal error of the power supply. This is usually caused by a component failure. To reset the error the power must be cycled on the power supply. If the error reoccurs the power supply must be repaired by the factory.

12V BIAS ERR ENABLE TO RESET

The “12V BIAS ERR” error is an internal error of the power supply. This is usually caused by a component failure. To reset the error the power must be cycled on the power supply. If the error reoccurs the power supply must be repaired by the factory.

3.3V BIAS ERR ENABLE TO RESET

The “3.3V BIAS ERR” error is an internal error of the power supply. This is usually caused by a component failure. To reset the error the power must be cycled on the power supply. If the error reoccurs the power supply must be repaired by the factory.

**PFC FAILURE
ENABLE TO RESET**

The “PFC FAILURE” error is an internal error of the power supply. This is usually caused by a component failure. To reset the error the power must be cycled on the power supply. If the error reoccurs the power supply must be repaired by the factory.

**HS TEMP ERROR
ENABLE TO RESET**

The “HS TEMP ERROR” error indicates an overtemperature of the main heatsink. This is usually caused an ambient temperature over 40C. To reset the power supply simply press the ENABLE button. If the error reoccurs and the ambient temperature is within specifications the power supply must be repaired by the factory.

**FAN STALL ERROR
ENABLE TO RESET**

The “FAN STALL ERROR” indicates that the fan is not running at the expected speed. This is usually caused by an obstruction in the fan or by a failed fan. To reset the power supply simply press the ENABLE button. If the error reoccurs the power supply must be repaired by the factory.

SELF-TEST ERROR ENABLE TO RESET

On power up, the power supply runs a check on several internal systems to make sure all is working well prior to power up. The “SELF-TEST ERROR” error is an internal error of the power supply that can occur during initial power on when the self-test is performed. The unit must be sent in to the factory for repair.

COMM TIMEOUT ENABLE TO RESET

“COMM TIMEOUT” indicates that one of the power supplies communication ports has not responded in a timely manner. To reset the power supply simply press the ENABLE button. If the error reoccurs the power supply must be repaired by the factory.

APPENDIX D – RACK MOUNT OPTION

Rack mounting of the Rack 1500 *XR* can be done with no changes to the unit. If the customer wishes to remove the rubber feet that is OK. Retain the feet and screws in case they are needed later.

CAUTION: If the feet are replaced with the incorrect screws damage to the power supply can occur. Be sure to use 6-32 screws with 3/8 inch length.

SERVICE INFORMATION

A Return Material Authorization (RMA) number must be obtained from Versatile Power before a power supply may be returned for repair.

Contact Versatile Power Customer Support at 408-341-4600 option 2 to obtain an RMA number.

When requesting an RMA please provide the following information:

Model number

Serial number

A description of the problem including the error indication if available

If possible, return the unit in its original packaging. Do not return the power cord. Please include the RMA number with the unit being returned. Units must be well packaged when shipping to Versatile Power; the repair of any damage incurred during shipping is not covered by warranty and will be charged to the customer.

Return all units to Versatile Power using pre-paid shipping.

For warranty repairs, Versatile Power covers the cost for return shipment to the customer via ground transportation to locations in the domestic US and Canada. For out-of-warranty repairs, overnight shipments and shipments to other countries please contact Versatile Power Customer Support for shipping fees.

Ship units to:

Versatile Power
RMA _____
743 Camden Avenue
Campbell, CA 95008

LIMITED THREE YEAR WARRANTY

Versatile Power warrants to the original purchaser that its products and the component parts will be free from defects in workmanship and materials for a period of three years from date of purchase. Versatile Power will, without charge, repair or replace, at its option, defective product or component parts.

This warranty does not apply in the event that:

- The product is damaged by misuse, accident, abuse or alterations.
- The product is opened, modified, disassembled or repaired without Versatile Power consent.
- The serial number is altered, defaced or removed.
- The product is found to have no defects, in which case a re-inspection and handling charge will be applied.

This warranty is in lieu of all other warranties, obligations, and liabilities, either expressed or implied, and are the purchaser's exclusive remedy. Versatile Power makes no warranty, either expressed or implied, of merchantability, fitness for a particular purpose or otherwise. In no event shall Versatile Power be liable whether in contract, tort or negligence, for special, indirect, incidental or consequential damages of any kind, including the loss of business or profits, or any other losses incurred by purchaser or any third party, the Customer's remedies being limited, at Versatile Power's option, to replacement, repair or credit at the original purchase price.

Versatile Power reserves the right to make changes or improvements to its products without any obligation to upgrade previously manufactured products.